

### Application

Extraction roof fans REX-V comply with the requirements of ATEX Directive 2014/34/UE, are designed for use in hazard zones excluding mines and mining pits, meets the requirements of group II category 2G/3G - zone 1 and/or 2 and category 2D/3D - zone 21 and/or 22.

### ATEX marking:

- II 2G Ex h IIB+H2 T3 Gb
- II 2G Ex h IIB+H2 T4 Gb
- II 2D Ex h IIIC T125°C Db

### Construction

- medium- pressure centrifugal fan with direct drive
- aluminium sheet impeller with forward curved blades, dynamically balanced according to ISO 1940-1,
- casing parts made of unpainted aluminium and stainless steel sheet,
- temperature of the transported medium is the same as the ambient temperature of the device (see technical data),
- minimum ambient temperature is -20°C,
- suitable for mounting a vibration sensor.

### Electric motor

- asynchronous, single-phase, 230V, 50Hz,
- asynchronous, three-phase, 230/400V 50Hz or 400/690V 50Hz (depending on the model),
- insulation class F,
- thermal protection PTC,
- VFD models suitable for frequency regulation.

### Special execution

- painted casing,
- different motor voltage and frequency,
- different motor degree of protection,
- impeller and casing made of stainless steel sheet,
- ambient temperature up to +60°C.

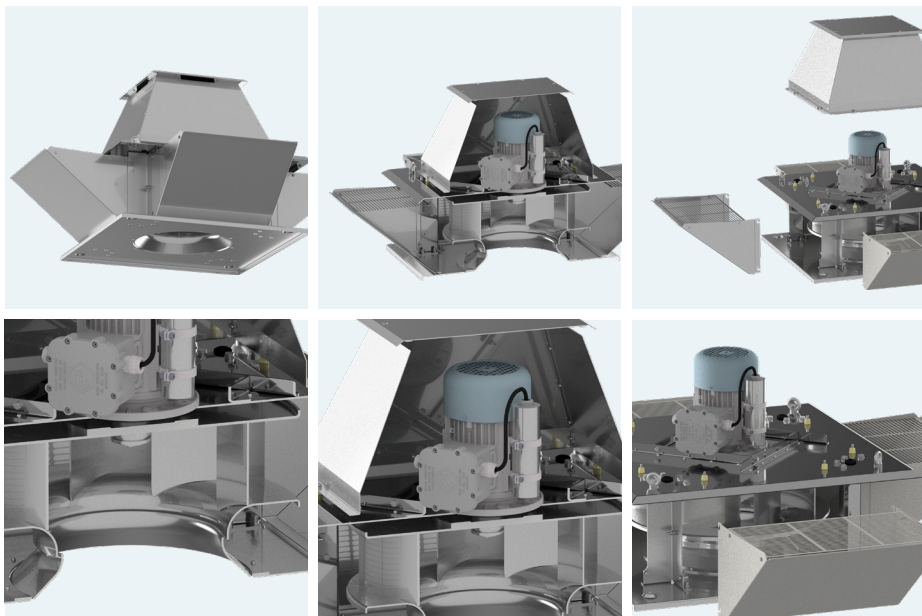

### RELATED PRODUCTS



**REX-H**  
Roof fan  
with horizontal  
discharge



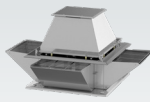

## NOMINAL DATA

type	airflow max	pressure max	speed	voltage rated	current max abs.**	power motor	sound pressure level*	temp. operating min / max	temp. ambient min / max	weight	article number
<b>2-POLE MOTORS 3000RPM</b>											
REX-V/2-190-012T 2G	730 m <sup>3</sup> /h	340 Pa	2 750 rpm	400 V	0,4 A	120 W	67 dB(A)	-20 / 40 °C	-20 / 40	12,5 kg	45526200
REX-V/2-190-012T 2G VFD	730 m <sup>3</sup> /h	340 Pa	2 800 rpm	400 V	0,48 A	120 W	67 dB(A)	-20 / 50 °C	-20 / 50	14,5 kg	425526201
REX-V/2-190-012T 2GD VFD	730 m <sup>3</sup> /h	340 Pa	2 800 rpm	400 V	0,48 A	120 W	67 dB(A)	-20 / 50 °C	-20 / 50	14,5 kg	425526202
REX-V/2-190-012S 2G	730 m <sup>3</sup> /h	340 Pa	2 880 rpm	230 V	1,3 A	120 W	67 dB(A)	-20 / 50 °C	-20 / 50	15,5 kg	45526203
REX-V/2-190-012S 2GD	730 m <sup>3</sup> /h	340 Pa	2 880 rpm	230 V	1,3 A	120 W	67 dB(A)	-20 / 50 °C	-20 / 50	15,5 kg	45526204
REX-V/2-220-012T 2G	1020 m <sup>3</sup> /h	435 Pa	2 750 rpm	400 V	0,4 A	120 W	68 dB(A)	-20 / 40 °C	-20 / 40	12,5 kg	45526210
REX-V/2-220-012T 2G VFD	1020 m <sup>3</sup> /h	435 Pa	2 800 rpm	400 V	0,48 A	120 W	68 dB(A)	-20 / 50 °C	-20 / 50	14,5 kg	425526211
REX-V/2-220-012T 2GD VFD	1020 m <sup>3</sup> /h	435 Pa	2 800 rpm	400 V	0,48 A	120 W	68 dB(A)	-20 / 50 °C	-20 / 50	14,5 kg	425526212
REX-V/2-220-012S 2G	1020 m <sup>3</sup> /h	435 Pa	2 880 rpm	230 V	1,3 A	120 W	68 dB(A)	-20 / 50 °C	-20 / 50	15,5 kg	45526213
REX-V/2-220-012S 2GD	1020 m <sup>3</sup> /h	435 Pa	2 880 rpm	230 V	1,3 A	120 W	68 dB(A)	-20 / 50 °C	-20 / 50	15,5 kg	45526214
REX-V/2-280(250)-025T 2G	1745 m <sup>3</sup> /h	630 Pa	2 870 rpm	400 V	0,9 A	250 W	71 dB(A)	-20 / 40 °C	-20 / 40	16,0 kg	45526220
REX-V/2-280(250)-025T 2G VFD	1745 m <sup>3</sup> /h	630 Pa	2 830 rpm	400 V	0,81 A	250 W	71 dB(A)	-20 / 50 °C	-20 / 50	18,0 kg	425526221
REX-V/2-280(250)-025T 2GD VFD	1745 m <sup>3</sup> /h	630 Pa	2 830 rpm	400 V	0,81 A	250 W	71 dB(A)	-20 / 50 °C	-20 / 50	18,0 kg	425526222
REX-V/2-280(250)-025S 2G	1745 m <sup>3</sup> /h	630 Pa	2 800 rpm	230 V	1,81 A	250 W	71 dB(A)	-20 / 50 °C	-20 / 50	18,0 kg	45526223
REX-V/2-280(250)-025S 2GD	1745 m <sup>3</sup> /h	630 Pa	2 800 rpm	230 V	1,81 A	250 W	71 dB(A)	-20 / 50 °C	-20 / 50	18,0 kg	45526224
<b>4-POLE MOTORS 1500RPM</b>											
REX-V/4-190-006T 2G	360 m <sup>3</sup> /h	80 Pa	1 380 rpm	400 V	0,31 A	60 W	52 dB(A)	-20 / 60 °C	-20 / 40	12,5 kg	45526400
REX-V/4-190-012T 2G VFD	360 m <sup>3</sup> /h	80 Pa	1 390 rpm	400 V	0,49 A	120 W	52 dB(A)	-20 / 60 °C	-20 / 50	15,0 kg	425526401
REX-V/4-190-012T 2GD VFD	360 m <sup>3</sup> /h	80 Pa	1 390 rpm	400 V	0,49 A	120 W	52 dB(A)	-20 / 60 °C	-20 / 50	15,0 kg	425526402
REX-V/4-190-009S 2G	360 m <sup>3</sup> /h	80 Pa	1 420 rpm	230 V	0,8 A	90 W	52 dB(A)	-20 / 60 °C	-20 / 50	15,5 kg	45526403
REX-V/4-190-009S 2GD	360 m <sup>3</sup> /h	80 Pa	1 420 rpm	230 V	0,8 A	90 W	52 dB(A)	-20 / 60 °C	-20 / 50	15,5 kg	45526404
REX-V/4-220-006T 2G	500 m <sup>3</sup> /h	105 Pa	1 380 rpm	400 V	0,31 A	60 W	53 dB(A)	-20 / 60 °C	-20 / 40	12,5 kg	45526410
REX-V/4-220-012T 2G VFD	500 m <sup>3</sup> /h	105 Pa	1 390 rpm	400 V	0,49 A	120 W	53 dB(A)	-20 / 60 °C	-20 / 50	15,0 kg	425526411
REX-V/4-220-012T 2GD VFD	500 m <sup>3</sup> /h	105 Pa	1 390 rpm	400 V	0,49 A	120 W	53 dB(A)	-20 / 60 °C	-20 / 50	15,0 kg	425526412
REX-V/4-220-009S 2G	500 m <sup>3</sup> /h	105 Pa	1 420 rpm	230 V	0,8 A	90 W	53 dB(A)	-20 / 60 °C	-20 / 50	15,5 kg	45526413
REX-V/4-220-009S 2GD	500 m <sup>3</sup> /h	105 Pa	1 420 rpm	230 V	0,8 A	90 W	53 dB(A)	-20 / 60 °C	-20 / 50	15,5 kg	45526414
REX-V/4-250-018T 2G	1100 m <sup>3</sup> /h	180 Pa	1 390 rpm	400 V	0,7 A	180 W	53 dB(A)	-20 / 60 °C	-20 / 40	16,5 kg	45526420
REX-V/4-250-018T 2G VFD	1100 m <sup>3</sup> /h	180 Pa	1 340 rpm	400 V	0,57 A	180 W	53 dB(A)	-20 / 60 °C	-20 / 50	17,5 kg	425526421
REX-V/4-250-018T 2GD VFD	1100 m <sup>3</sup> /h	180 Pa	1 340 rpm	400 V	0,57 A	180 W	53 dB(A)	-20 / 60 °C	-20 / 50	17,5 kg	425526422
REX-V/4-250-018S 2G	1100 m <sup>3</sup> /h	180 Pa	1 355 rpm	230 V	1,38 A	180 W	53 dB(A)	-20 / 60 °C	-20 / 50	18,5 kg	45526423
REX-V/4-250-018S 2GD	1100 m <sup>3</sup> /h	180 Pa	1 355 rpm	230 V	1,38 A	180 W	53 dB(A)	-20 / 60 °C	-20 / 50	18,5 kg	45526424
REX-V/4-280-025T 2G	1570 m <sup>3</sup> /h	230 Pa	1 370 rpm	400 V	0,85 A	250 W	56 dB(A)	-20 / 60 °C	-20 / 40	18,0 kg	45526430
REX-V/4-280-025T 2G VFD	1570 m <sup>3</sup> /h	230 Pa	1 430 rpm	400 V	0,79 A	250 W	56 dB(A)	-20 / 60 °C	-20 / 50	20,0 kg	425526431
REX-V/4-280-025T 2GD VFD	1570 m <sup>3</sup> /h	230 Pa	1 430 rpm	400 V	0,79 A	250 W	56 dB(A)	-20 / 60 °C	-20 / 50	20,0 kg	425526432
REX-V/4-280-025S 2G	1570 m <sup>3</sup> /h	230 Pa	1 450 rpm	230 V	2 A	250 W	56 dB(A)	-20 / 60 °C	-20 / 50	21,0 kg	45526433
REX-V/4-280-025S 2GD	1570 m <sup>3</sup> /h	230 Pa	1 450 rpm	230 V	2 A	250 W	56 dB(A)	-20 / 60 °C	-20 / 50	21,0 kg	45526434
REX-V/4-315-037T 2G	2 210 m <sup>3</sup> /h	290 Pa	1 350 rpm	400 V	1,15 A	370 W	59 dB(A)	-20 / 60 °C	-20 / 40	25,5 kg	45526440
REX-V/4-315-037T 2G VFD	2 210 m <sup>3</sup> /h	290 Pa	1 420 rpm	400 V	1,08 A	370 W	59 dB(A)	-20 / 60 °C	-20 / 50	26,6 kg	425526441
REX-V/4-315-037T 2GD VFD	2 210 m <sup>3</sup> /h	290 Pa	1 420 rpm	400 V	1,08 A	370 W	59 dB(A)	-20 / 60 °C	-20 / 50	25,5 kg	425526442
REX-V/4-315-037S 2G	2 210 m <sup>3</sup> /h	290 Pa	1 430 rpm	230 V	2,55 A	370 W	59 dB(A)	-20 / 60 °C	-20 / 50	28,0 kg	45526443
REX-V/4-315-037S 2GD	2 210 m <sup>3</sup> /h	290 Pa	1 430 rpm	230 V	2,55 A	370 W	59 dB(A)	-20 / 60 °C	-20 / 50	28,0 kg	45526444
REX-V/4-355-055T 2G	3 130 m <sup>3</sup> /h	375 Pa	1 360 rpm	400 V	1,5 A	550 W	62 dB(A)	-20 / 60 °C	-20 / 40	32,5 kg	45526450
REX-V/4-355-055T 2G VFD	3 130 m <sup>3</sup> /h	375 Pa	1 440 rpm	400 V	1,32 A	550 W	62 dB(A)	-20 / 60 °C	-20 / 50	35,0 kg	425526451
REX-V/4-355-055T 2GD VFD	3 130 m <sup>3</sup> /h	375 Pa	1 440 rpm	400 V	1,32 A	550 W	62 dB(A)	-20 / 60 °C	-20 / 50	35,0 kg	425526452

\* Measurement made at a distance of 1.5m from the outlet, for Q = 2/3 \* Qmax

\*\* the value of the rated current may vary depending on the manufacturer of the electric motor used.

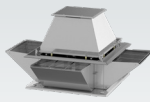

### NOMINAL DATA

type	airflow max	pressure max	speed	voltage rated	current max abs.**	power motor	sound pressure level*	temp. operating min / max	temp. ambient min / max	weight	article number
REX-V/4-355-055S 2G	3 130 m³/h	375 Pa	1 440 rpm	230 V	3,7 A	550 W	62 dB(A)	-20 / 60 °C	-20 / 50	35,0 kg	45526453
REX-V/4-355-055S 2GD	3 130 m³/h	375 Pa	1 440 rpm	230 V	3,7 A	550 W	62 dB(A)	-20 / 60 °C	-20 / 50	35,0 kg	45526454
REX-V/4-400-075T 2G	4 600 m³/h	475 Pa	1 360 rpm	400 V	1,9 A	750 W	65 dB(A)	-20 / 60 °C	-20 / 40	41,0 kg	45526460
REX-V/4-400-075T 2G VFD	4 600 m³/h	475 Pa	1 445 rpm	400 V	1,85 A	750 W	65 dB(A)	-20 / 60 °C	-20 / 50	45,0 kg	435526461
REX-V/4-400-075T 2GD VFD	4 600 m³/h	475 Pa	1 445 rpm	400 V	1,85 A	750 W	65 dB(A)	-20 / 60 °C	-20 / 50	45,0 kg	435526462
REX-V/4-400-075S 2G	4 600 m³/h	475 Pa	1 410 rpm	230 V	4,74 A	750 W	65 dB(A)	-20 / 60 °C	-20 / 50	44,0 kg	45526463
REX-V/4-400-075S 2GD	4 600 m³/h	475 Pa	1 410 rpm	230 V	4,74 A	750 W	65 dB(A)	-20 / 60 °C	-20 / 50	44,0 kg	45526464
REX-V/4-450-110T 2G	6 540 m³/h	620 Pa	1 405 rpm	400 V	2,7 A	1100 W	68 dB(A)	-20 / 60 °C	-20 / 40	53,5 kg	45526470
REX-V/4-450-110T 2G VFD	6 540 m³/h	620 Pa	1 440 rpm	400 V	2,61 A	1100 W	68 dB(A)	-20 / 60 °C	-20 / 50	56,5 kg	435526471
REX-V/4-450-110T 2GD VFD	6 540 m³/h	620 Pa	1 440 rpm	400 V	2,61 A	1100 W	68 dB(A)	-20 / 60 °C	-20 / 50	56,5 kg	435526472
REX-V/4-450-110S 2G	6 540 m³/h	620 Pa	1 440 rpm	230 V	7,6 A	1100 W	68 dB(A)	-20 / 60 °C	-20 / 50	55,5 kg	45526473
REX-V/4-450-110S 2GD	6 540 m³/h	620 Pa	1 440 rpm	230 V	7,6 A	1100 W	68 dB(A)	-20 / 60 °C	-20 / 50	55,5 kg	45526474
REX-V/4-500-220T 2G	8 940 m³/h	740 Pa	1 425 rpm	400 V	5,2 A	2200 W	71 dB(A)	-20 / 60 °C	-20 / 40	70,5 kg	45526480
REX-V/4-500-220T 2G VFD	8 940 m³/h	740 Pa	1 440 rpm	400 V	4,9 A	2200 W	71 dB(A)	-20 / 60 °C	-20 / 50	74,5 kg	435526481
REX-V/4-500-220T 2GD VFD	8 940 m³/h	740 Pa	1 440 rpm	400 V	4,9 A	2200 W	71 dB(A)	-20 / 60 °C	-20 / 50	74,5 kg	435526482
REX-V/4-560-300T 2G	12 530 m³/h	920 Pa	1 415 rpm	400 V	6,9 A	3000 W	75 dB(A)	-20 / 60 °C	-20 / 40	81,0 kg	45526490
REX-V/4-560-300T 2G VFD	12 530 m³/h	920 Pa	1 455 rpm	400 V	6,05 A	3000 W	75 dB(A)	-20 / 60 °C	-20 / 50	91,0 kg	435526491
REX-V/4-560-300T 2GD VFD	12 530 m³/h	920 Pa	1 455 rpm	400 V	6,05 A	3000 W	75 dB(A)	-20 / 60 °C	-20 / 50	91,0 kg	435526492
<b>6-POLE MOTORS 1000RPM</b>											
REX-V/6-250-018T 2G	725 m³/h	75 Pa	880 rpm	400 V	0,7 A	180 W	50 dB(A)	-20 / 60 °C	-20 / 40	17,0 kg	45526620
REX-V/6-250-012T 2G VFD	725 m³/h	75 Pa	935 rpm	400 V	0,59 A	120 W	50 dB(A)	-20 / 60 °C	-20 / 50	18,5 kg	425526621
REX-V/6-250-012T 2GD VFD	725 m³/h	75 Pa	935 rpm	400 V	0,59 A	120 W	50 dB(A)	-20 / 60 °C	-20 / 50	18,5 kg	425526622
REX-V/6-280-018T 2G	1 025 m³/h	100 Pa	880 rpm	400 V	0,7 A	180 W	53 dB(A)	-20 / 60 °C	-20 / 40	18,0 kg	45526630
REX-V/6-280-012T 2G VFD	1 025 m³/h	100 Pa	935 rpm	400 V	0,59 A	120 W	53 dB(A)	-20 / 60 °C	-20 / 50	19,0 kg	425526631
REX-V/6-280-012T 2GD VFD	1 025 m³/h	100 Pa	935 rpm	400 V	0,59 A	120 W	53 dB(A)	-20 / 60 °C	-20 / 50	19,0 kg	425526632
REX-V/6-315-018T 2G	1 450 m³/h	125 Pa	880 rpm	400 V	0,7 A	180 W	56 dB(A)	-20 / 60 °C	-20 / 40	24,5 kg	45526640
REX-V/6-315-012T 2G VFD	1 450 m³/h	125 Pa	935 rpm	400 V	0,59 A	120 W	56 dB(A)	-20 / 60 °C	-20 / 50	25,5 kg	425526641
REX-V/6-315-012T 2GD VFD	1 450 m³/h	125 Pa	935 rpm	400 V	0,59 A	120 W	56 dB(A)	-20 / 60 °C	-20 / 50	25,5 kg	425526642
REX-V/6-355-018T 2G	2 050 m³/h	160 Pa	880 rpm	400 V	0,7 A	180 W	59 dB(A)	-20 / 60 °C	-20 / 40	30,0 kg	45526650
REX-V/6-355-018T 2G VFD	2 050 m³/h	160 Pa	925 rpm	400 V	0,82 A	180 W	59 dB(A)	-20 / 60 °C	-20 / 50	32,0 kg	425526651
REX-V/6-355-018T 2GD VFD	2 050 m³/h	160 Pa	925 rpm	400 V	0,82 A	180 W	59 dB(A)	-20 / 60 °C	-20 / 50	32,0 kg	425526652
REX-V/6-400-025T 2G	3 020 m³/h	205 Pa	900 rpm	400 V	0,85 A	250 W	62 dB(A)	-20 / 60 °C	-20 / 40	38,0 kg	45526660
REX-V/6-400-025T 2G VFD	3 020 m³/h	205 Pa	930 rpm	400 V	0,88 A	250 W	62 dB(A)	-20 / 60 °C	-20 / 50	40,0 kg	425526661
REX-V/6-400-025T 2GD VFD	3 020 m³/h	205 Pa	930 rpm	400 V	0,88 A	250 W	62 dB(A)	-20 / 60 °C	-20 / 50	40,0 kg	425526662
REX-V/6-450-037T 2G	4 290 m³/h	270 Pa	920 rpm	400 V	1,3 A	370 W	65 dB(A)	-20 / 60 °C	-20 / 40	48,5 kg	45526670
REX-V/6-450-037T 2G VFD	4 290 m³/h	270 Pa	945 rpm	400 V	1,05 A	370 W	65 dB(A)	-20 / 60 °C	-20 / 50	51,5 kg	425526671
REX-V/6-450-037T 2GD VFD	4 290 m³/h	270 Pa	945 rpm	400 V	1,05 A	370 W	65 dB(A)	-20 / 60 °C	-20 / 50	51,5 kg	425526672
REX-V/6-500-075T 2G	5 860 m³/h	320 Pa	915 rpm	400 V	2,1 A	750 W	68 dB(A)	-20 / 60 °C	-20 / 40	66,0 kg	45526680
REX-V/6-500-075T 2G VFD	5 860 m³/h	320 Pa	945 rpm	400 V	1,96 A	750 W	68 dB(A)	-20 / 60 °C	-20 / 50	66,0 kg	435526681
REX-V/6-500-075T 2GD VFD	5 860 m³/h	320 Pa	945 rpm	400 V	1,96 A	750 W	68 dB(A)	-20 / 60 °C	-20 / 50	66,0 kg	435526682
REX-V/6-560-110T 2G	8 210 m³/h	400 Pa	920 rpm	400 V	3 A	1100 W	72 dB(A)	-20 / 60 °C	-20 / 40	73,0 kg	45526690
REX-V/6-560-110T 2G VFD	8 210 m³/h	400 Pa	950 rpm	400 V	2,7 A	1100 W	72 dB(A)	-20 / 60 °C	-20 / 50	79,0 kg	435526691
REX-V/6-560-110T 2GD VFD	8 210 m³/h	400 Pa	950 rpm	400 V	2,7 A	1100 W	72 dB(A)	-20 / 60 °C	-20 / 50	79,0 kg	435526692
REX-V/6-630-220T 2G	11 890 m³/h	520 Pa	960 rpm	400 V	5,1 A	2200 W	76 dB(A)	-20 / 60 °C	-20 / 40	122,0 kg	45526700
REX-V/6-630-220T 2G VFD	11 890 m³/h	520 Pa	955 rpm	400 V	5,2 A	2200 W	76 dB(A)	-20 / 60 °C	-20 / 50	133,0 kg	435526701

\* Measurement made at a distance of 1.5m from the outlet, for Q = 2/3 \* Qmax  
 \*\* the value of the rated current may vary depending on the manufacturer of the electric motor used.

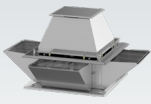

## NOMINAL DATA

type	airflow max	pressure max	speed	voltage rated	current max abs.**	power motor	sound pressure level*	temp. operating min / max	temp. ambient min / max	weight	article number
REX-V/6-630-220T 2GD VFD	11 890 m <sup>3</sup> /h	520 Pa	955 rpm	400 V	5,2 A	2200 W	76 dB(A)	-20 / 60 °C	-20 / 50	133,0 kg	435526702
REX-V/6-710-300T 2G	16 960 m <sup>3</sup> /h	660 Pa	950 rpm	400 V	6,8 A	3000 W	80 dB(A)	-20 / 60 °C	-20 / 40	165,0 kg	45526710
REX-V/6-710-300T 2G VFD	16 960 m <sup>3</sup> /h	660 Pa	965 rpm	400 V	6,32 A	3000 W	80 dB(A)	-20 / 60 °C	-20 / 50	160,0 kg	435526711
REX-V/6-710-300T 2GD VFD	16 960 m <sup>3</sup> /h	660 Pa	965 rpm	400 V	6,32 A	3000 W	80 dB(A)	-20 / 60 °C	-20 / 50	160,0 kg	435526712
REX-V/6-800-550T 2G	25 220 m <sup>3</sup> /h	875 Pa	950 rpm	400 V	11,6 A	5500 W	84 dB(A)	-20 / 60 °C	-20 / 40	228,0 kg	45526720
REX-V/6-800-550T 2G VFD	25 220 m <sup>3</sup> /h	875 Pa	970 rpm	400 V	11,4 A	5500 W	84 dB(A)	-20 / 60 °C	-20 / 50	260,0 kg	435526721
REX-V/6-800-550T 2GD VFD	25 220 m <sup>3</sup> /h	875 Pa	970 rpm	400 V	11,4 A	5500 W	84 dB(A)	-20 / 60 °C	-20 / 50	260,0 kg	435526722

\* Measurement made at a distance of 1.5m from the outlet, for Q = 2/3 \* Qmax

\*\* the value of the rated current may vary depending on the manufacturer of the electric motor used.

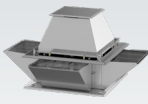

### PERFORMANCE CHARACTERISTICS OF THE FANS - 2-POLE MOTORS 3000RPM

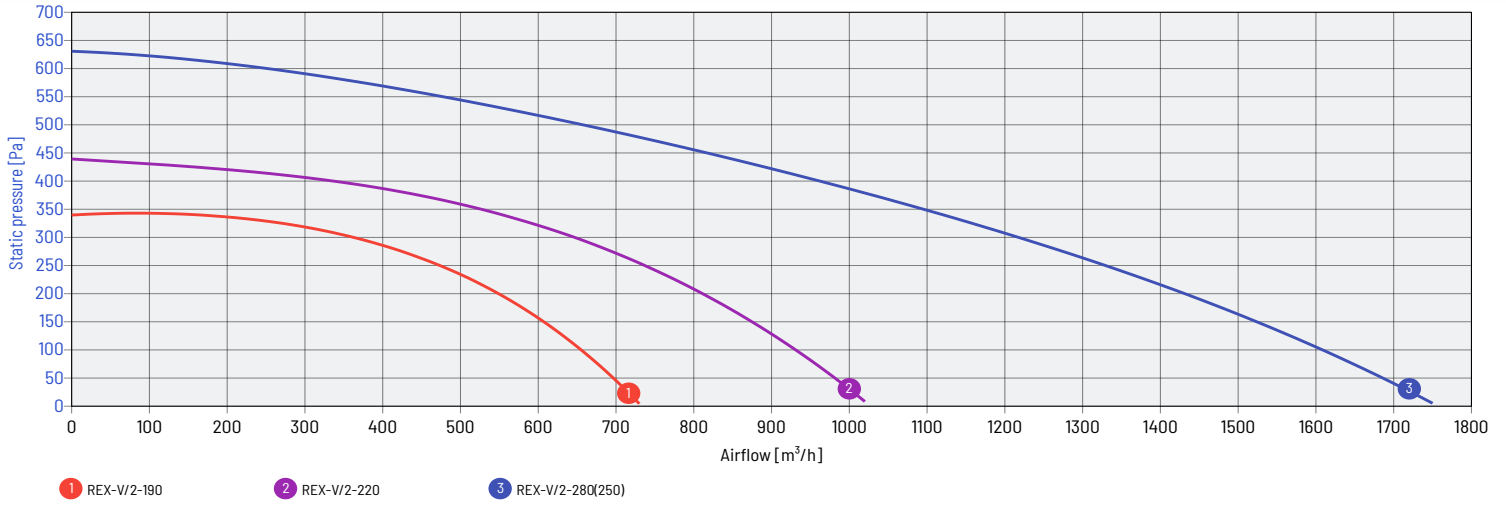

### PERFORMANCE CHARACTERISTICS OF THE FANS - 4-POLE MOTORS 1500RPM

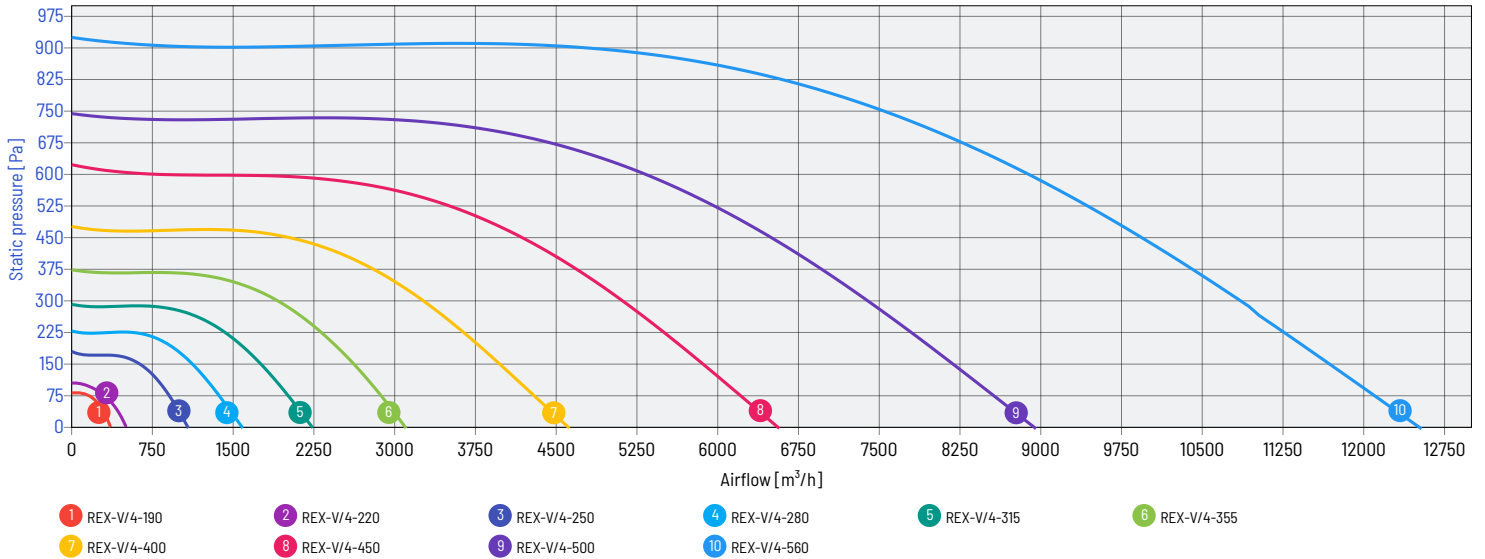

### PERFORMANCE CHARACTERISTICS OF THE FANS - 6-POLE MOTORS 1000RPM

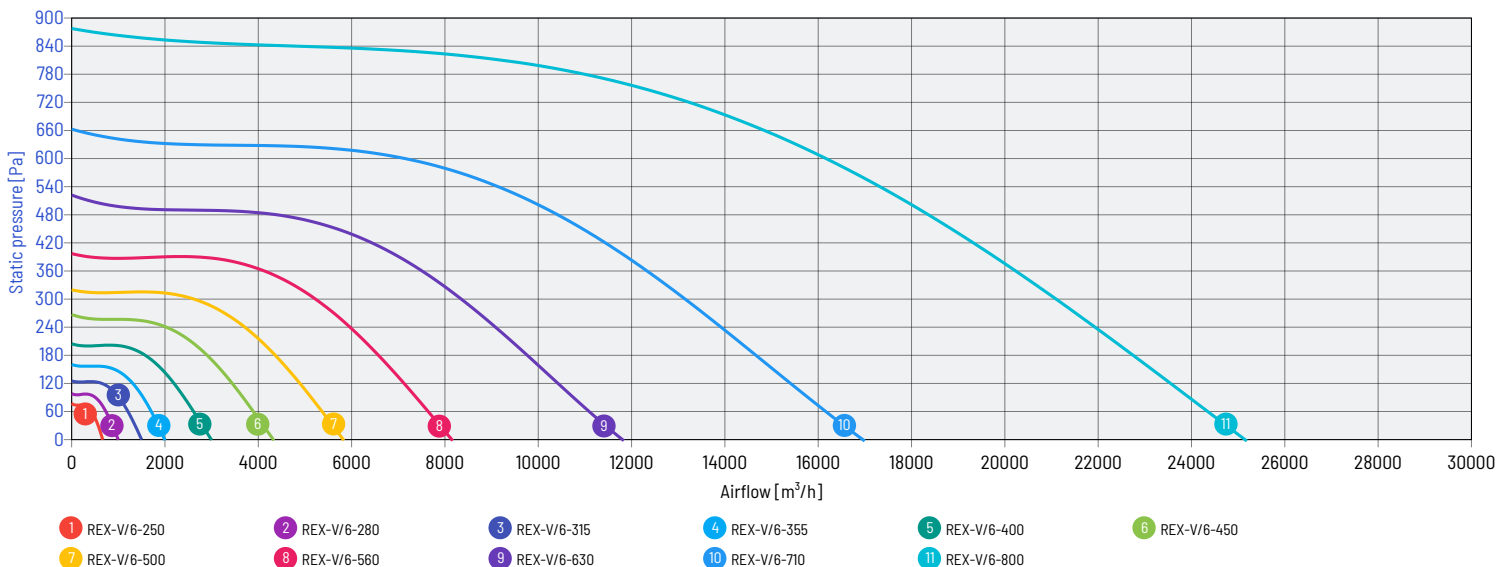

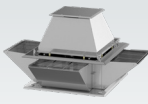

## PERFORMANCE CHARACTERISTICS OF THE FANS

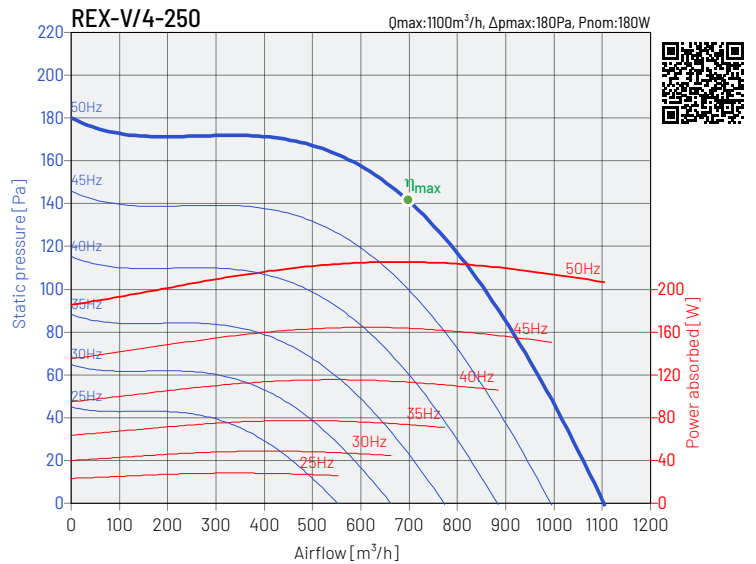
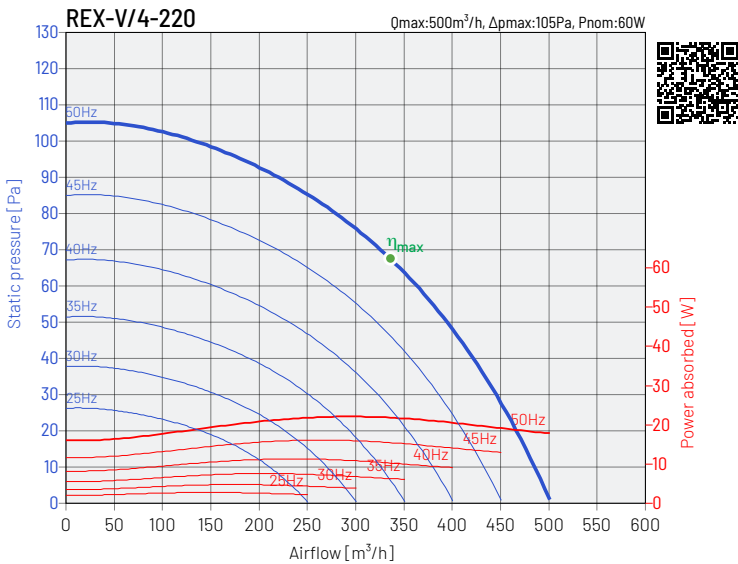
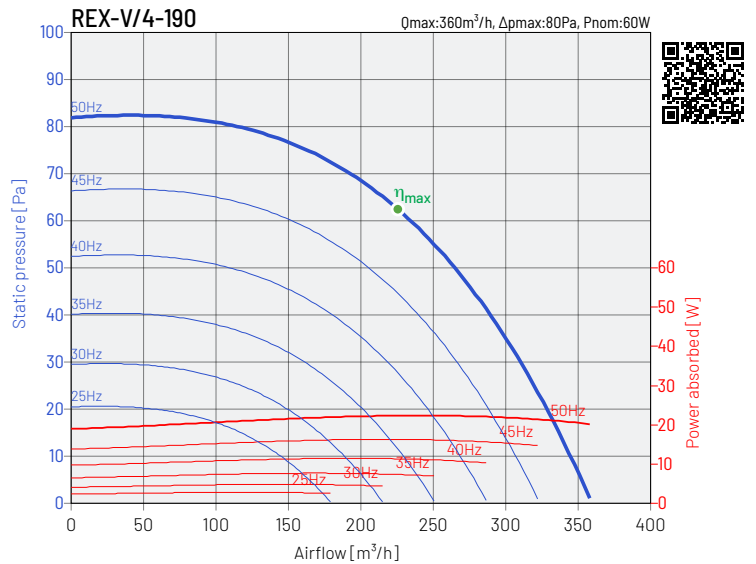
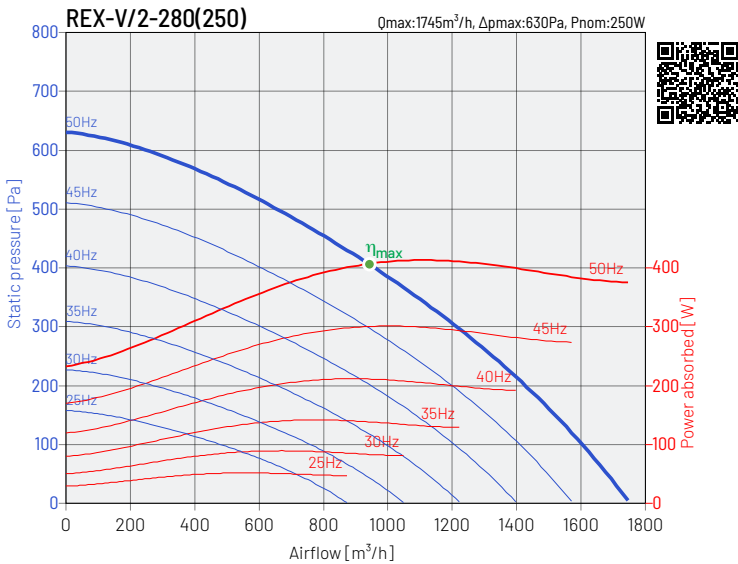
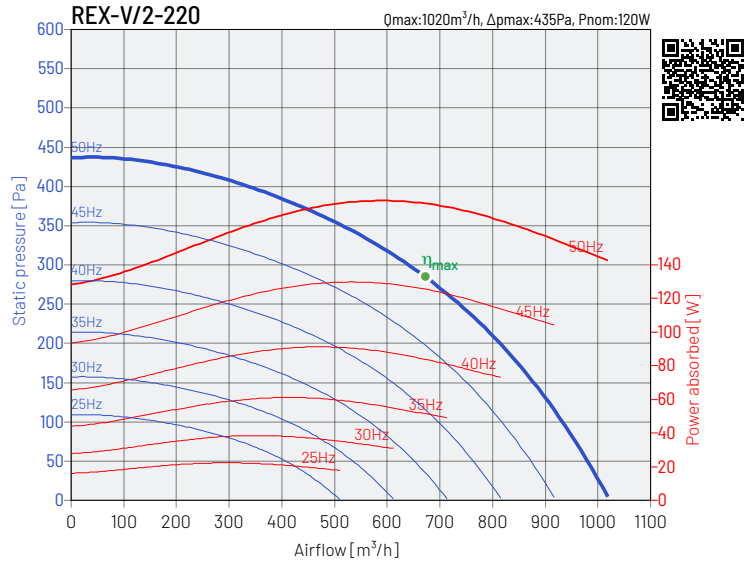
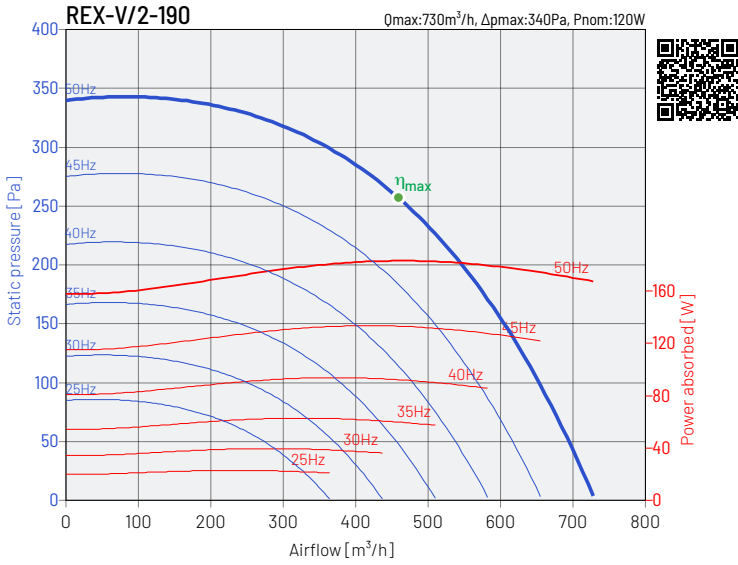

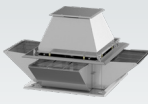

## PERFORMANCE CHARACTERISTICS OF THE FANS

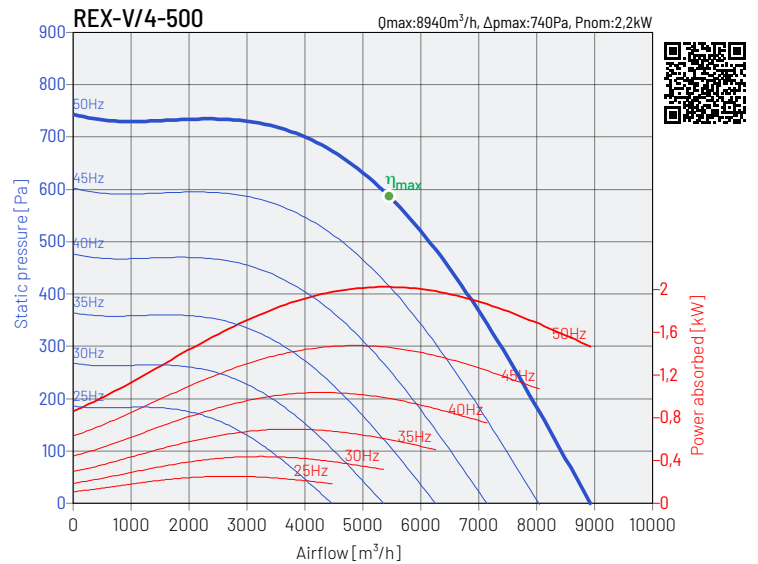
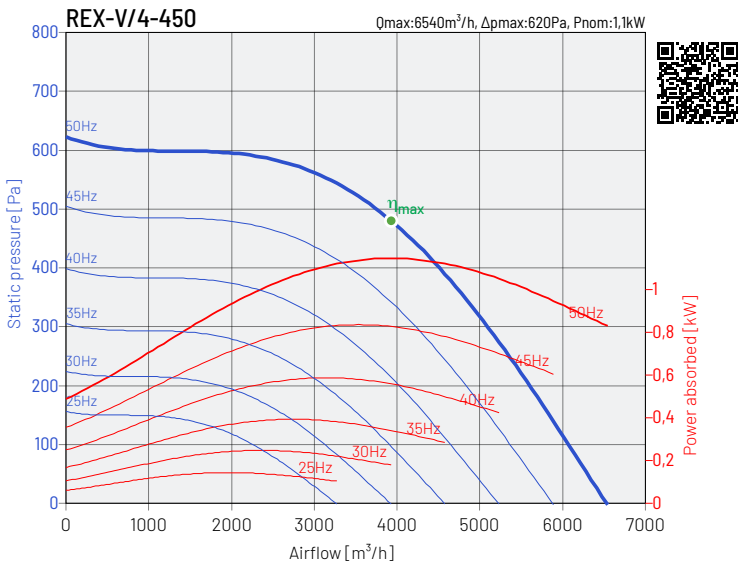
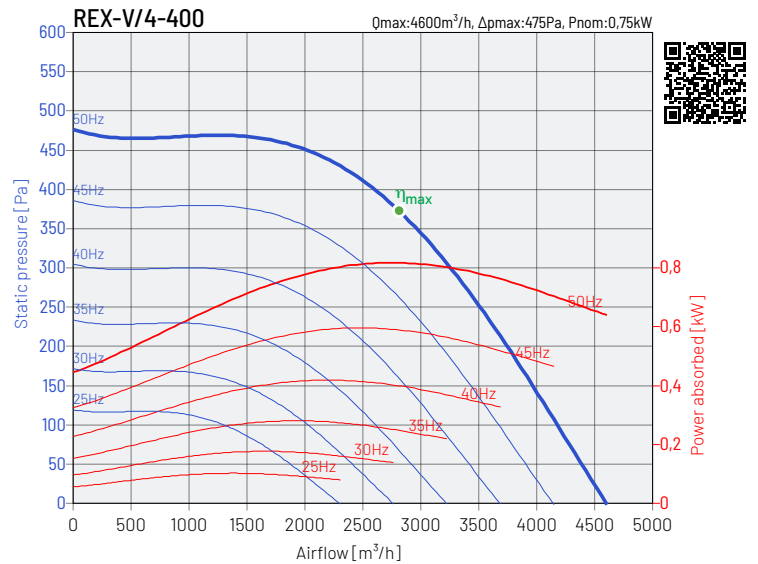
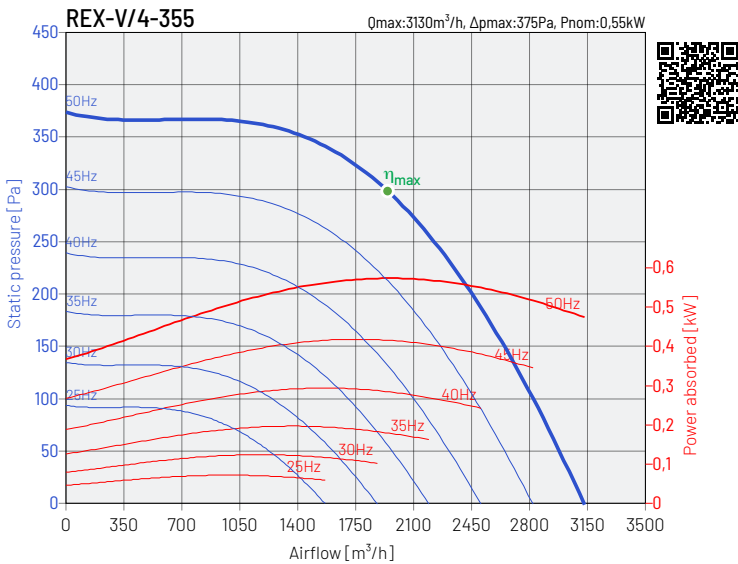
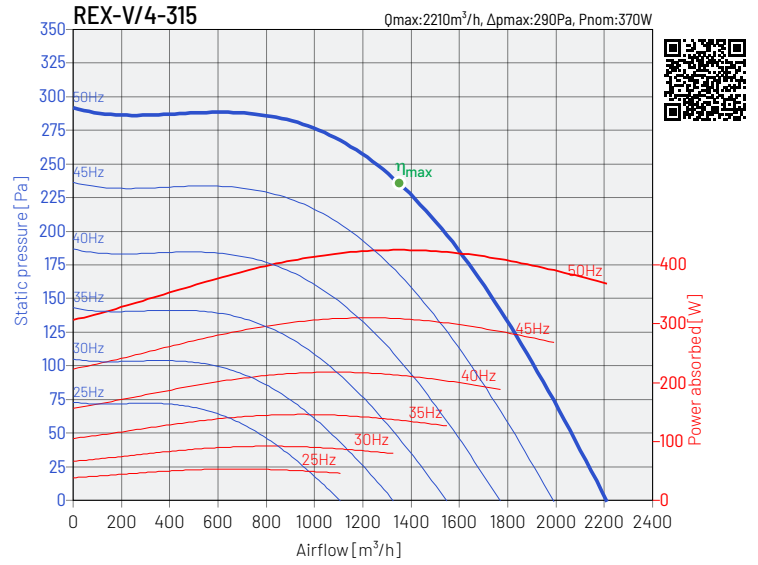
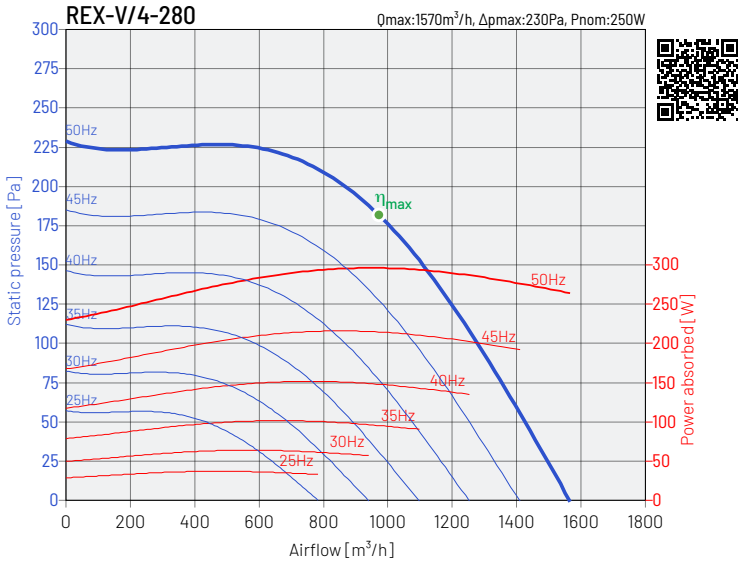

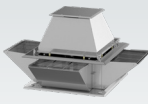

## PERFORMANCE CHARACTERISTICS OF THE FANS

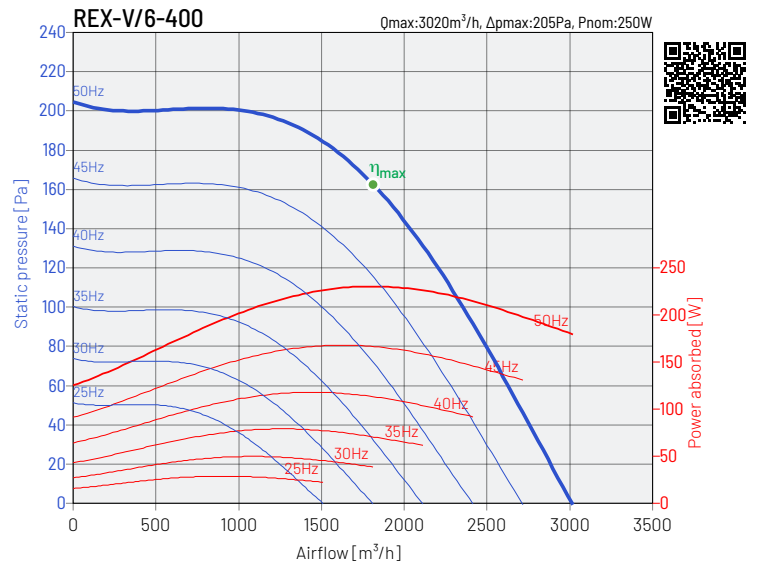
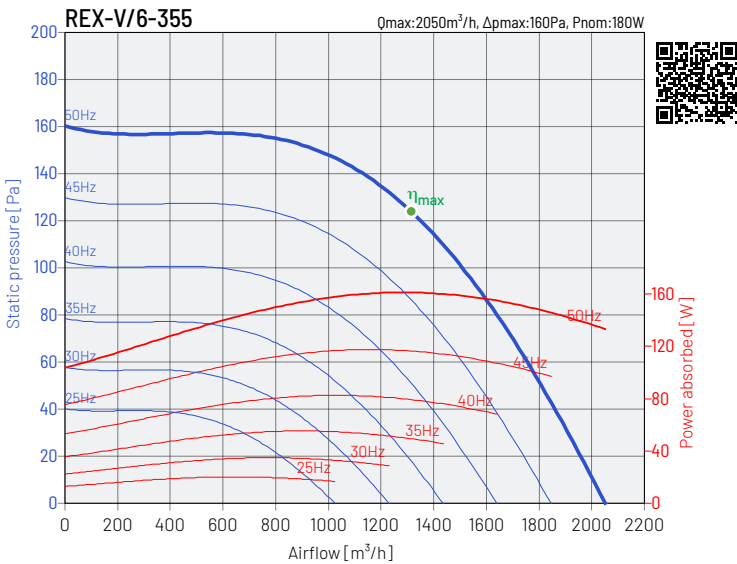
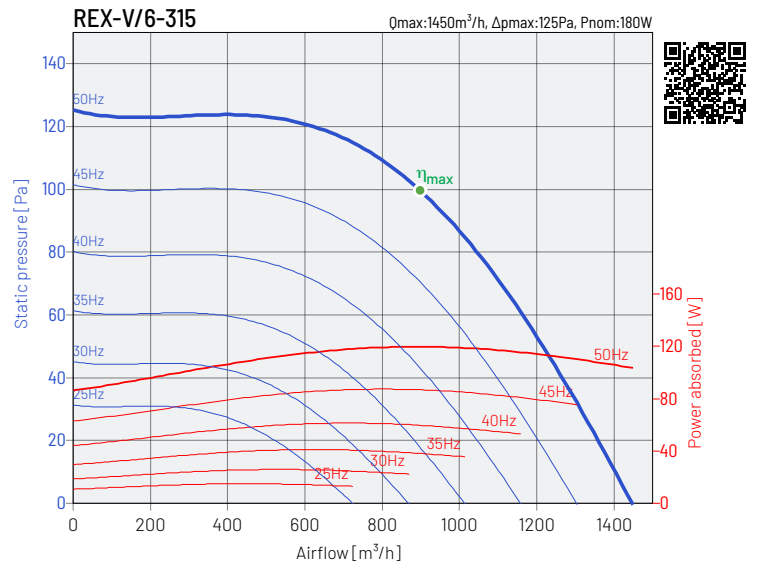
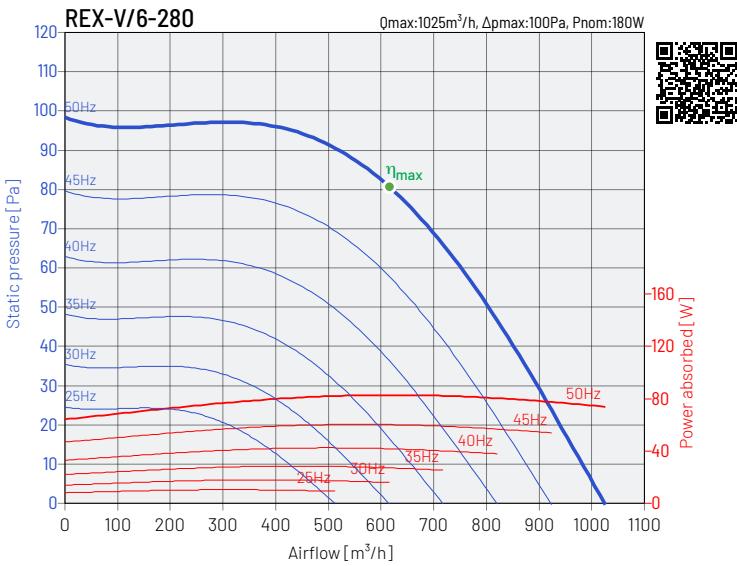
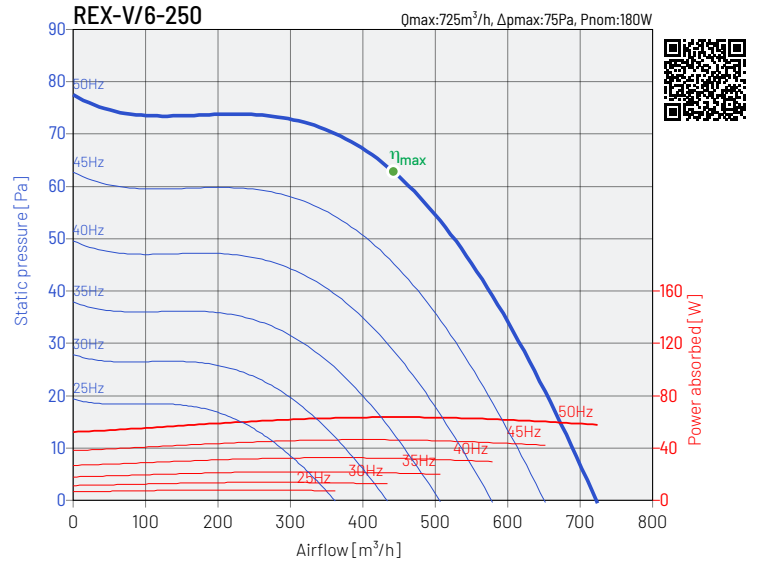
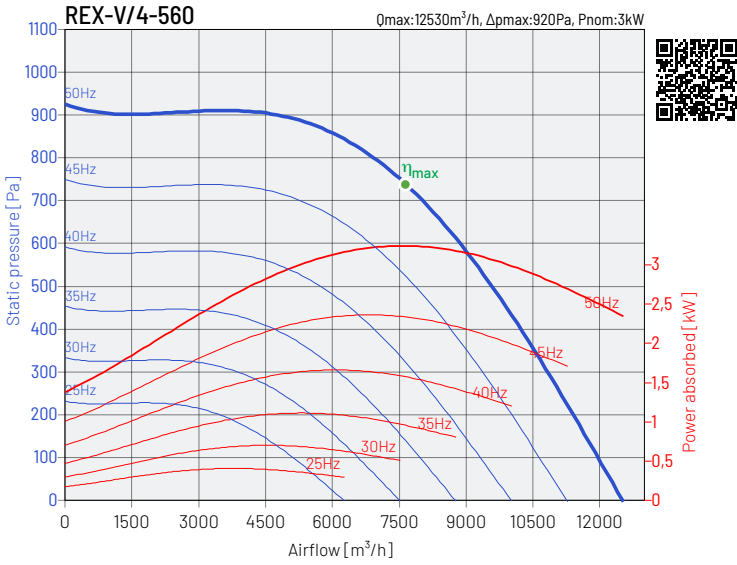



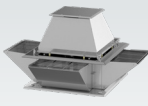

PERFORMANCE CHARACTERISTICS OF THE FANS

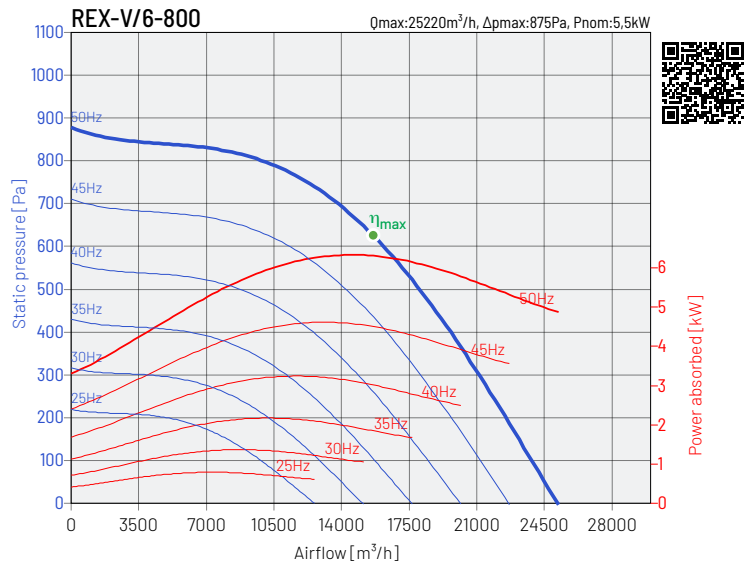
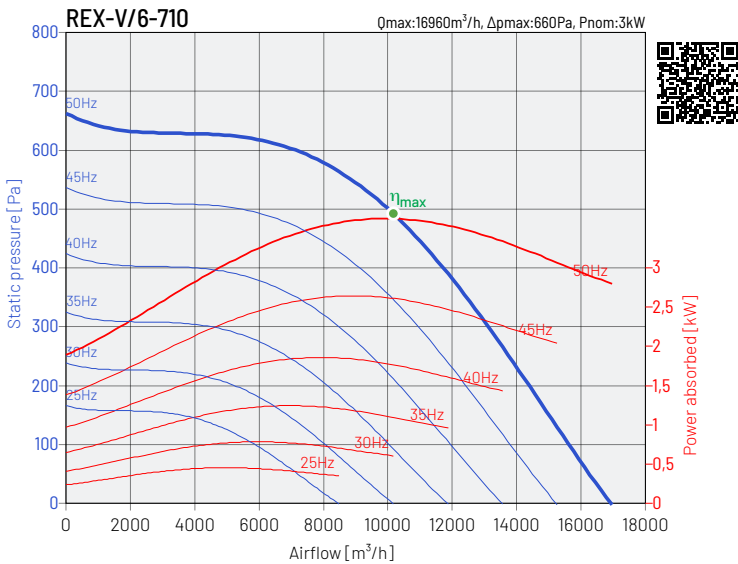
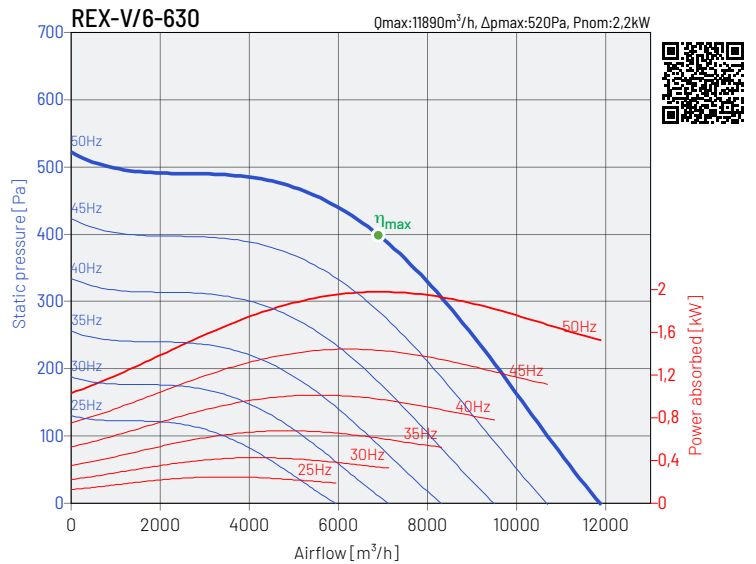
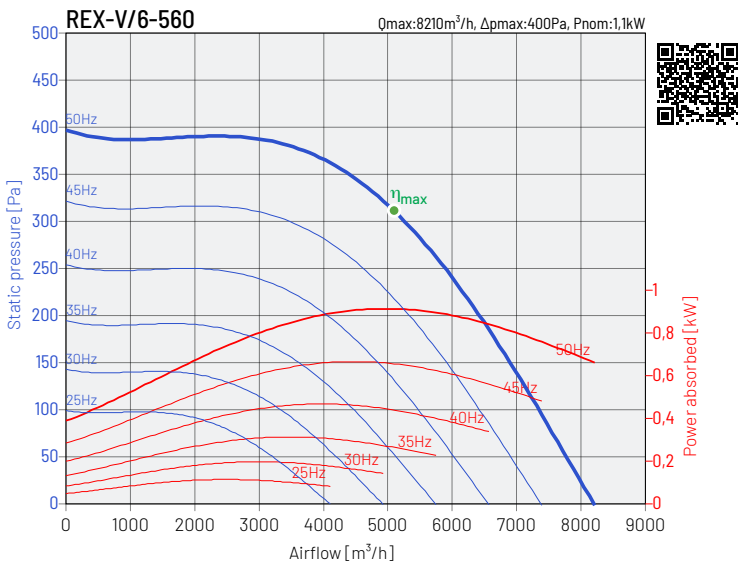
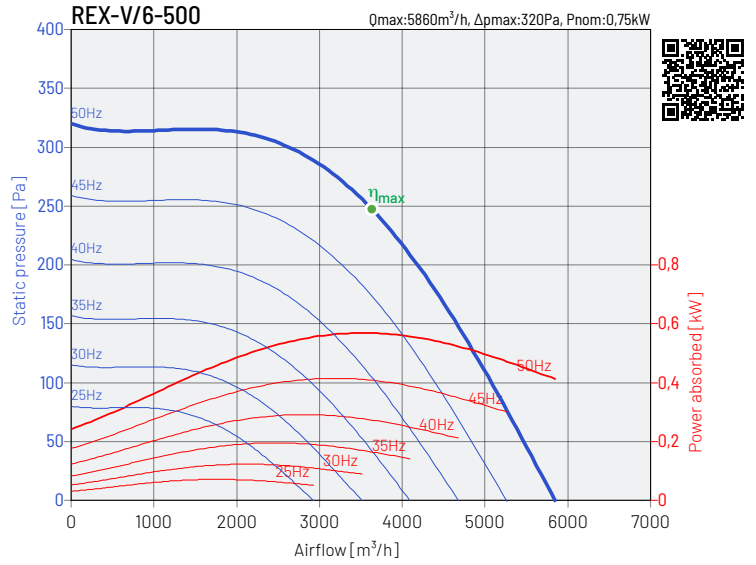
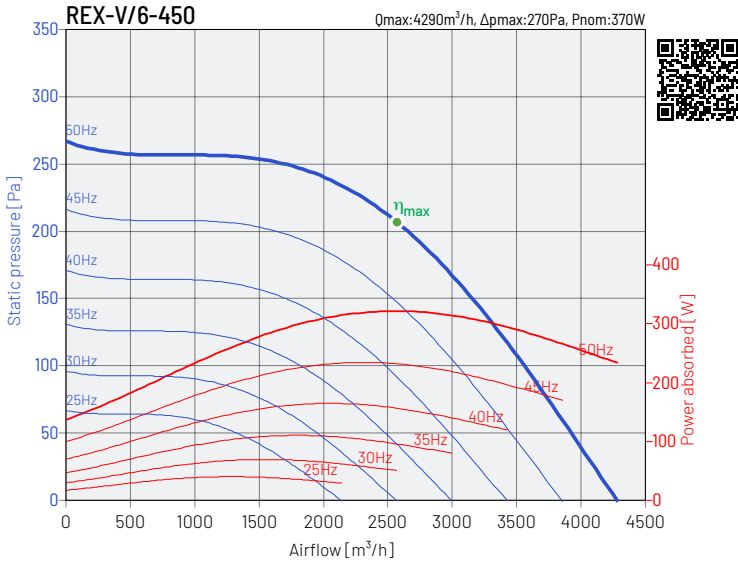

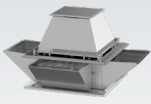

DIMENSIONS

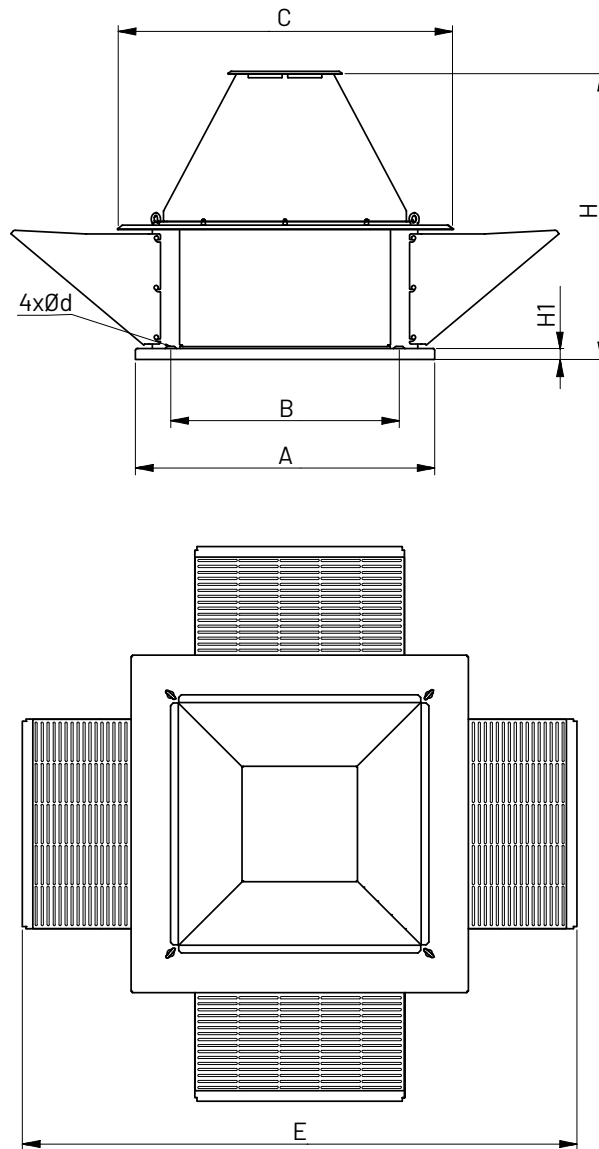

type	A mm	B mm	C mm	Ød mm	E mm	H mm	H1 mm
REX-x-190	435	330	386	12	593	385	15
REX-x-220	435	330	386	12	593	385	15
REX-x-250	435	330	441	12	735	453	15
REX-2-280	435	330	441	12	637	416	15
REX-4-280	435	330	441	12	735	453	15
REX-x-315	560	450	513	12	833	495	15
REX-x-355	560	450	583	12	952	540	15

type	A mm	B mm	C mm	Ød mm	E mm	H mm	H1 mm
REX-x-400	560	450	653	12	1045	554	15
REX-x-450	710	590	731	12	1212	603	15
REX-x-500	710	590	811	12	1343	707	15
REX-x-560	710	590	896	12	1520	781	15
REX-x-630	900	750	1001	14	1604	797	40
REX-x-710	900	750	1121	14	1782	885	40
REX-x-800	1100	840	1241	14	2040	1060	40

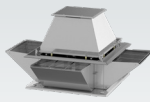

MOUNTING ACCESSORIES

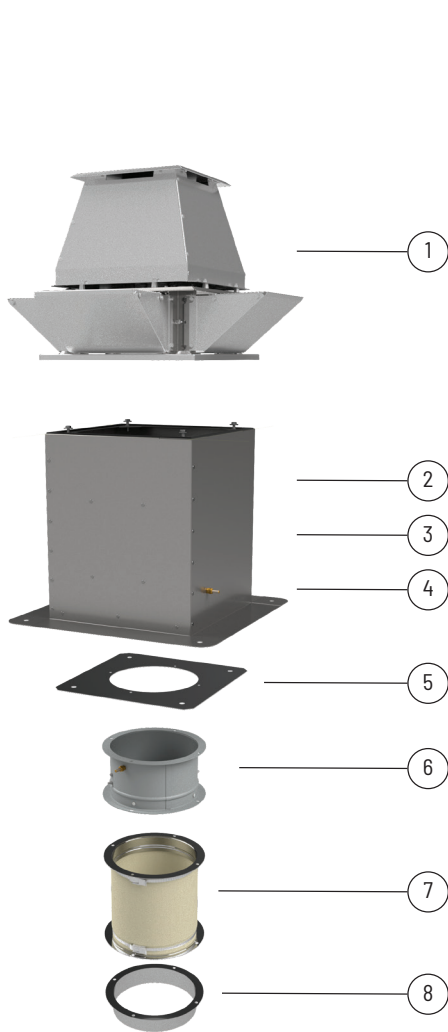

	1	2	3	4	5
<b>type</b>		<b>flat roof up RSS/EX</b>	<b>flat roof up RS/EX</b>	<b>flat roof up RSA/EX</b>	<b>mounting plate P/EX</b>
REX-V/x-190		RSS/EX-435	RS/EX-435	RSA/EX-435	P/EX-435
REX-V/x-220		RSS/EX-435	RS/EX-435	RSA/EX-435	P/EX-435
REX-V/x-250		RSS/EX-435	RS/EX-435	RSA/EX-435	P/EX-435
REX-V/x-280		RSS/EX-435	RS/EX-435	RSA/EX-435	P/EX-435
REX-V/x-315		RSS/EX-560	RS/EX-560	RSA/EX-560	P/EX-560
REX-V/x-355		RSS/EX-560	RS/EX-560	RSA/EX-560	P/EX-560
REX-V/x-400		RSS/EX-560	RS/EX-560	RSA/EX-560	P/EX-560
REX-V/x-450		RSS/EX-710	RS/EX-710	RSA/EX-710	P/EX-710
REX-V/x-500		RSS/EX-710	RS/EX-710	RSA/EX-710	P/EX-710
REX-V/x-560		RSS/EX-710	RS/EX-710	RSA/EX-710	P/EX-710
REX-V/x-630		RSS/EX-900	RS/EX-900	RSA/EX-900	P/EX-900
REX-V/x-710		RSS/EX-900	RS/EX-900	RSA/EX-900	P/EX-900
REX-V/x-800		RSS/EX-1100	RS/EX-1100	RSA/EX-1100	P/EX-1100

	1	6	7	8
<b>type</b>		<b>backflow preventer KZD/EX</b>	<b>zconnector anti-vibration ZPDO/EX</b>	<b>stub pipe K/EX</b>
REX-V/x-190		KZD/EX-435	ZPDO/EX-435	K/EX-435
REX-V/x-220		KZD/EX-435	ZPDO/EX-435	K/EX-435
REX-V/x-250		KZD/EX-435	ZPDO/EX-435	K/EX-435
REX-V/x-280		KZD/EX-435	ZPDO/EX-435	K/EX-435
REX-V/x-315		KZD/EX-560	ZPDO/EX-560	K/EX-560
REX-V/x-355		KZD/EX-560	ZPDO/EX-560	K/EX-560
REX-V/x-400		KZD/EX-560	ZPDO/EX-560	K/EX-560
REX-V/x-450		KZD/EX-710	ZPDO/EX-710	K/EX-710
REX-V/x-500		KZD/EX-710	ZPDO/EX-710	K/EX-710
REX-V/x-560		KZD/EX-710	ZPDO/EX-710	K/EX-710
REX-V/x-630		KZD/EX-900	ZPDO/EX-900	K/EX-900
REX-V/x-710		KZD/EX-900	ZPDO/EX-900	K/EX-900
REX-V/x-800		KZD/EX-1100	ZPDO/EX-1100	K/EX-1100

Article numbers

43527601	RSS/EX-435	43527621	RSA/EX-435	43527631	P/EX-435	43527641	KZD/EX-435	43527651	ZPDO/EX-435	43527661	K/EX-435
43527602	RSS/EX-560	43527622	RSA/EX-560	43527632	P/EX-560	43527642	KZD/EX-560	43527652	ZPDO/EX-560	43527662	K/EX-560
43527603	RSS/EX-710	43527623	RSA/EX-710	43527633	P/EX-710	43527643	KZD/EX-710	43527653	ZPDO/EX-710	43527663	K/EX-710
43527604	RSS/EX-900	43527624	RSA/EX-900	43527634	P/EX-900	43527644	KZD/EX-900	43527654	ZPDO/EX-900	43527664	K/EX-900
43527605	RSS/EX-1100	43527625	RSA/EX-1100	43527635	P/EX-1100	43527645	KZD/EX-1100	43527655	ZPDO/EX-1100	43527665	K/EX-1100
43527611	RS/EX-435										
43527612	RS/EX-560										
43527613	RS/EX-710										
43527614	RS/EX-900										
43527615	RS/EX-1100										

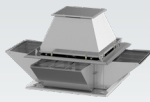

## ELECTRICAL ACCESSORIES



type	inverter L	switch PTC	service switch	contactor
<b>2-POLE MOTORS 3000RPM</b>				
REX-V/2-190-012T 2G	-	U-EK230	R-S 3-F + SP, 16A	DILM7-10(230V50HZ)
REX-V/2-190-012T 2G VFD	L 0,4 kW	U-EK230	R-S 3-F + SP, 16A	DILM7-10(230V50HZ)
REX-V/2-190-012T 2GD VFD	L 0,4 kW	U-EK230	R-S 3-F + SP, 16A	DILM7-10(230V50HZ)
REX-V/2-190-012S 2G	-	U-EK230	R-S 1-F + SP, 16A	DILM7-10(230V50HZ)
REX-V/2-190-012S 2GD	-	U-EK230	R-S 1-F + SP, 16A	DILM7-10(230V50HZ)
REX-V/2-220-012T 2G	-	U-EK230	R-S 3-F + SP, 16A	DILM7-10(230V50HZ)
REX-V/2-220-012T 2G VFD	L 0,4 kW	U-EK230	R-S 3-F + SP, 16A	DILM7-10(230V50HZ)
REX-V/2-220-012T 2GD VFD	L 0,4 kW	U-EK230	R-S 3-F + SP, 16A	DILM7-10(230V50HZ)
REX-V/2-220-012S 2G	-	U-EK230	R-S 1-F + SP, 16A	DILM7-10(230V50HZ)
REX-V/2-220-012S 2GD	-	U-EK230	R-S 1-F + SP, 16A	DILM7-10(230V50HZ)
REX-V/2-280(250)-025T 2G	-	U-EK230	R-S 3-F + SP, 16A	DILM7-10(230V50HZ)
REX-V/2-280(250)-025T 2G VFD	L 0,4 kW	U-EK230	R-S 3-F + SP, 16A	DILM7-10(230V50HZ)
REX-V/2-280(250)-025T 2GD VFD	L 0,4 kW	U-EK230	R-S 3-F + SP, 16A	DILM7-10(230V50HZ)
REX-V/2-280(250)-025S 2G	-	U-EK230	R-S 1-F + SP, 16A	DILM7-10(230V50HZ)
REX-V/2-280(250)-025S 2GD	-	U-EK230	R-S 1-F + SP, 16A	DILM7-10(230V50HZ)
<b>4-POLE MOTORS 1500RPM</b>				
REX-V/4-190-006T 2G	-	U-EK230	R-S 3-F + SP, 16A	DILM7-10(230V50HZ)
REX-V/4-190-012T 2G VFD	L 0,4 kW	U-EK230	R-S 3-F + SP, 16A	DILM7-10(230V50HZ)
REX-V/4-190-012T 2GD VFD	L 0,4 kW	U-EK230	R-S 3-F + SP, 16A	DILM7-10(230V50HZ)
REX-V/4-190-009S 2G	-	U-EK230	R-S 1-F + SP, 16A	DILM7-10(230V50HZ)
REX-V/4-190-009S 2GD	-	U-EK230	R-S 1-F + SP, 16A	DILM7-10(230V50HZ)
REX-V/4-220-006T 2G	-	U-EK230	R-S 3-F + SP, 16A	DILM7-10(230V50HZ)
REX-V/4-220-012T 2G VFD	L 0,4 kW	U-EK230	R-S 3-F + SP, 16A	DILM7-10(230V50HZ)
REX-V/4-220-012T 2GD VFD	L 0,4 kW	U-EK230	R-S 3-F + SP, 16A	DILM7-10(230V50HZ)
REX-V/4-220-009S 2G	-	U-EK230	R-S 1-F + SP, 16A	DILM7-10(230V50HZ)
REX-V/4-220-009S 2GD	-	U-EK230	R-S 1-F + SP, 16A	DILM7-10(230V50HZ)
REX-V/4-250-018T 2G	-	U-EK230	R-S 3-F + SP, 16A	DILM7-10(230V50HZ)
REX-V/4-250-018T 2G VFD	L 0,4 kW	U-EK230	R-S 3-F + SP, 16A	DILM7-10(230V50HZ)
REX-V/4-250-018T 2GD VFD	L 0,4 kW	U-EK230	R-S 3-F + SP, 16A	DILM7-10(230V50HZ)
REX-V/4-250-018S 2G	-	U-EK230	R-S 1-F + SP, 16A	DILM7-10(230V50HZ)
REX-V/4-250-018S 2GD	-	U-EK230	R-S 1-F + SP, 16A	DILM7-10(230V50HZ)
REX-V/4-280-025T 2G	-	U-EK230	R-S 3-F + SP, 16A	DILM7-10(230V50HZ)
REX-V/4-280-025T 2G VFD	L 0,4 kW	U-EK230	R-S 3-F + SP, 16A	DILM7-10(230V50HZ)
REX-V/4-280-025T 2GD VFD	L 0,4 kW	U-EK230	R-S 3-F + SP, 16A	DILM7-10(230V50HZ)
REX-V/4-280-025S 2G	-	U-EK230	R-S 1-F + SP, 16A	DILM7-10(230V50HZ)
REX-V/4-280-025S 2GD	-	U-EK230	R-S 1-F + SP, 16A	DILM7-10(230V50HZ)
REX-V/4-315-037T 2G	-	U-EK230	R-S 3-F + SP, 16A	DILM7-10(230V50HZ)
REX-V/4-315-037T 2G VFD	L 0,4 kW	U-EK230	R-S 3-F + SP, 16A	DILM7-10(230V50HZ)
REX-V/4-315-037T 2GD VFD	L 0,4 kW	U-EK230	R-S 3-F + SP, 16A	DILM7-10(230V50HZ)
REX-V/4-315-037S 2G	-	U-EK230	R-S 1-F + SP, 16A	DILM7-10(230V50HZ)
REX-V/4-315-037S 2GD	-	U-EK230	R-S 1-F + SP, 16A	DILM7-10(230V50HZ)
REX-V/4-355-055T 2G	-	U-EK230	R-S 3-F + SP, 16A	DILM7-10(230V50HZ)
REX-V/4-355-055T 2G VFD	L 0,75 kW	U-EK230	R-S 3-F + SP, 16A	DILM7-10(230V50HZ)
REX-V/4-355-055T 2GD VFD	L 0,75 kW	U-EK230	R-S 3-F + SP, 16A	DILM7-10(230V50HZ)
REX-V/4-355-055S 2G	-	U-EK230	R-S 1-F + SP, 16A	DILM7-10(230V50HZ)
REX-V/4-355-055S 2GD	-	U-EK230	R-S 1-F + SP, 16A	DILM7-10(230V50HZ)
REX-V/4-400-075T 2G	-	U-EK230	R-S 3-F + SP, 16A	DILM7-10(230V50HZ)
REX-V/4-400-075T 2G VFD	L 0,75 kW	U-EK230	R-S 3-F + SP, 16A	DILM7-10(230V50HZ)

\* equipment for the safe zone, execution for the ATEX zone consult with the Technical Department of Venture Industries Sp. z o.o.

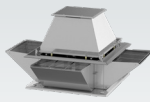

## ELECTRICAL ACCESSORIES



type	inverter L	switch PTC	service switch	contactor
REX-V/4-400-075T 2GD VFD	L 0,75 kW	U-EK230	R-S 3-F + SP, 16A	DILM7-10(230V50HZ)
REX-V/4-400-075S 2G	-	U-EK230	R-S 1-F + SP, 16A	DILM7-10(230V50HZ)
REX-V/4-400-075S 2GD	-	U-EK230	R-S 1-F + SP, 16A	DILM7-10(230V50HZ)
REX-V/4-450-110T 2G	-	U-EK230	R-S 3-F + SP, 16A	DILM7-10(230V50HZ)
REX-V/4-450-110T 2G VFD	L 1,5 kW	U-EK230	R-S 3-F + SP, 16A	DILM7-10(230V50HZ)
REX-V/4-450-110T 2GD VFD	L 1,5 kW	U-EK230	R-S 3-F + SP, 16A	DILM7-10(230V50HZ)
REX-V/4-450-110S 2G	-	U-EK230	R-S 1-F + SP, 16A	DILM7-10(230V50HZ)
REX-V/4-450-110S 2GD	-	U-EK230	R-S 1-F + SP, 16A	DILM7-10(230V50HZ)
REX-V/4-500-220T 2G	-	U-EK230	R-S 3-F + SP, 16A	DILM7-10(230V50HZ)
REX-V/4-500-220T 2G VFD	L 2,2 kW	U-EK230	R-S 3-F + SP, 16A	DILM7-10(230V50HZ)
REX-V/4-500-220T 2GD VFD	L 2,2 kW	U-EK230	R-S 3-F + SP, 16A	DILM7-10(230V50HZ)
REX-V/4-560-300T 2G	-	U-EK230	R-S 3-F + SP, 16A	DILM7-10(230V50HZ)
REX-V/4-560-300T 2G VFD	L 3 kW	U-EK230	R-S 3-F + SP, 16A	DILM7-10(230V50HZ)
REX-V/4-560-300T 2GD VFD	L 3 kW	U-EK230	R-S 3-F + SP, 16A	DILM7-10(230V50HZ)
<b>6-POLE MOTORS 1000RPM</b>				
REX-V/6-250-018T 2G	-	U-EK230	R-S 3-F + SP, 16A	DILM7-10(230V50HZ)
REX-V/6-250-012T 2G VFD	L 0,4 kW	U-EK230	R-S 3-F + SP, 16A	DILM7-10(230V50HZ)
REX-V/6-250-012T 2GD VFD	L 0,4 kW	U-EK230	R-S 3-F + SP, 16A	DILM7-10(230V50HZ)
REX-V/6-280-018T 2G	-	U-EK230	R-S 3-F + SP, 16A	DILM7-10(230V50HZ)
REX-V/6-280-012T 2G VFD	L 0,4 kW	U-EK230	R-S 3-F + SP, 16A	DILM7-10(230V50HZ)
REX-V/6-280-012T 2GD VFD	L 0,4 kW	U-EK230	R-S 3-F + SP, 16A	DILM7-10(230V50HZ)
REX-V/6-315-018T 2G	-	U-EK230	R-S 3-F + SP, 16A	DILM7-10(230V50HZ)
REX-V/6-315-012T 2G VFD	L 0,4 kW	U-EK230	R-S 3-F + SP, 16A	DILM7-10(230V50HZ)
REX-V/6-315-012T 2GD VFD	L 0,4 kW	U-EK230	R-S 3-F + SP, 16A	DILM7-10(230V50HZ)
REX-V/6-355-018T 2G	-	U-EK230	R-S 3-F + SP, 16A	DILM7-10(230V50HZ)
REX-V/6-355-018T 2G VFD	L 0,4 kW	U-EK230	R-S 3-F + SP, 16A	DILM7-10(230V50HZ)
REX-V/6-355-018T 2GD VFD	L 0,4 kW	U-EK230	R-S 3-F + SP, 16A	DILM7-10(230V50HZ)
REX-V/6-400-025T 2G	-	U-EK230	R-S 3-F + SP, 16A	DILM7-10(230V50HZ)
REX-V/6-400-025T 2G VFD	L 0,4 kW	U-EK230	R-S 3-F + SP, 16A	DILM7-10(230V50HZ)
REX-V/6-400-025T 2GD VFD	L 0,4 kW	U-EK230	R-S 3-F + SP, 16A	DILM7-10(230V50HZ)
REX-V/6-450-037T 2G	-	U-EK230	R-S 3-F + SP, 16A	DILM7-10(230V50HZ)
REX-V/6-450-037T 2G VFD	L 0,4 kW	U-EK230	R-S 3-F + SP, 16A	DILM7-10(230V50HZ)
REX-V/6-450-037T 2GD VFD	L 0,4 kW	U-EK230	R-S 3-F + SP, 16A	DILM7-10(230V50HZ)
REX-V/6-500-075T 2G	-	U-EK230	R-S 3-F + SP, 16A	DILM7-10(230V50HZ)
REX-V/6-500-075T 2G VFD	L 0,75 kW	U-EK230	R-S 3-F + SP, 16A	DILM7-10(230V50HZ)
REX-V/6-500-075T 2GD VFD	L 0,75 kW	U-EK230	R-S 3-F + SP, 16A	DILM7-10(230V50HZ)
REX-V/6-560-110T 2G	-	U-EK230	R-S 3-F + SP, 16A	DILM7-10(230V50HZ)
REX-V/6-560-110T 2G VFD	L 1,5 kW	U-EK230	R-S 3-F + SP, 16A	DILM7-10(230V50HZ)
REX-V/6-560-110T 2GD VFD	L 1,5 kW	U-EK230	R-S 3-F + SP, 16A	DILM7-10(230V50HZ)
REX-V/6-630-220T 2G	-	U-EK230	R-S 3-F + SP, 16A	DILM7-10(230V50HZ)
REX-V/6-630-220T 2G VFD	L 2,2 kW	U-EK230	R-S 3-F + SP, 16A	DILM7-10(230V50HZ)
REX-V/6-630-220T 2GD VFD	L 2,2 kW	U-EK230	R-S 3-F + SP, 16A	DILM7-10(230V50HZ)
REX-V/6-710-300T 2G	-	U-EK230	R-S 3-F + SP, 16A	DILM7-10(230V50HZ)
REX-V/6-710-300T 2G VFD	L 4,0 kW	U-EK230	R-S 3-F + SP, 16A	DILM7-10(230V50HZ)
REX-V/6-710-300T 2GD VFD	L 4,0 kW	U-EK230	R-S 3-F + SP, 16A	DILM7-10(230V50HZ)
REX-V/6-800-550T 2G	-	U-EK230	R-S 3-F + SP, 25A/6	DILM12-10(230V50HZ)
REX-V/6-800-550T 2G VFD	L 5,5 kW	U-EK230	R-S 3-F + SP, 25A	DILM12-10(230V50HZ)
REX-V/6-800-550T 2GD VFD	L 5,5 kW	U-EK230	R-S 3-F + SP, 25A	DILM12-10(230V50HZ)

\* equipment for the safe zone, execution for the ATEX zone consult with the Technical Department of Venture Industries Sp. z o.o.