

ROOF-H Roof fan

The power of AIR



Application

Range of centrifugal roof mounted fans in horizontal discharge format.

ROOF-H are designed for ventilation:

- warehouses, shop and industrial halls, farm buildings in agriculture, etc.

Due to their high temperature resistance, they are especially recommended as extractors:

- from over grates, from hoods in the meat industry and gastronomy.

Construction

- rotors with backward blades are made of aluminum sheet,
- the base and outer casing are made of aluminum sheet,
- brackets and motor support plate are made of stainless steel,
- canopy made of aluminum sheet,
- rotor cover made of powder coated steel,
- designed for vertical work,
- suitable for mounting on flat roofs,
- working temperature -40°C to $+120^{\circ}\text{C}$.

Motor

- asynchronous single-phase 230V 50Hz (power to 1,1 kW)
- asynchronous 3-phase 230 / 400V, 50Hz (power up to 3,0 kW),
- asynchronous 3-phase 400 / 690V, 50Hz (power from 4,0 kW),
- degree of protection IP55,
- insulation class F,
- single-phase motors are adapted to voltage regulation,
- three-phase motors are adapted for frequency converter.



RELATED PRODUCTS

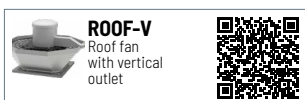



NOMINAL DATA

type	airflow max	pressure max	speed	voltage rated	current max abs.**	power max abs.	sound pressure level*	weight	article number
SINGLE-PHASE, 4-POLE MOTORS									
ROOF-H/25/12/14S	1 220 m ³ /h	185 Pa	1 420 rpm	230 V	1,4 A	0,18 kW	54 dB(A)	17,0 kg	43534396
ROOF-H/28/17/14S	1 700 m ³ /h	235 Pa	1 340 rpm	230 V	1,7 A	0,25 kW	57 dB(A)	19,0 kg	43534401
ROOF-H/31/24/14S	2 400 m ³ /h	300 Pa	1 420 rpm	230 V	2,8 A	0,37 kW	60 dB(A)	22,0 kg	43534406
ROOF-H/35/34/14S	3 400 m ³ /h	385 Pa	1 430 rpm	230 V	3,8 A	0,55 kW	63 dB(A)	32,0 kg	43534411
ROOF-H/40/50/14S	5 000 m ³ /h	490 Pa	1 430 rpm	230 V	4,1 A	0,75 kW	66 dB(A)	36,0 kg	43534416
ROOF-H/45/71/14S	7 100 m ³ /h	620 Pa	1 300 rpm	230 V	7,5 A	1,1 kW	69 dB(A)	50,0 kg	43534421
SINGLE-PHASE, 6-POLE MOTORS									
ROOF-H/25/08/09S	800 m ³ /h	80 Pa	880 rpm	230 V	1,4 A	0,12 kW	52 dB(A)	18,0 kg	43534398
ROOF-H/28/11/09S	1 100 m ³ /h	105 Pa	880 rpm	230 V	1,4 A	0,12 kW	54 dB(A)	18,0 kg	43534403
ROOF-H/31/16/09S	1 600 m ³ /h	130 Pa	880 rpm	230 V	1,4 A	0,12 kW	57 dB(A)	20,0 kg	43534408
ROOF-H/35/22/09S	2 250 m ³ /h	170 Pa	920 rpm	230 V	1,6 A	0,18 kW	60 dB(A)	28,0 kg	43534413
ROOF-H/40/32/09S	3 200 m ³ /h	215 Pa	940 rpm	230 V	2,3 A	0,25 kW	63 dB(A)	33,0 kg	43534418
ROOF-H/45/47/09S	4 700 m ³ /h	270 Pa	930 rpm	230 V	2,9 A	0,37 kW	66 dB(A)	44,0 kg	43534423
ROOF-H/50/64/09S	6 400 m ³ /h	340 Pa	940 rpm	230 V	5,2 A	0,75 kW	69 dB(A)	55,0 kg	43534428
THREE-PHASE, 4-POLE MOTORS									
ROOF-H/25/12/14T	1 220 m ³ /h	185 Pa	1 400 rpm	400 V	0,55 A	0,18 kW	54 dB(A)	19,0 kg	43534395
ROOF-H/28/17/14T	1 700 m ³ /h	235 Pa	1 410 rpm	400 V	0,8 A	0,25 kW	57 dB(A)	20,0 kg	43534400
ROOF-H/31/24/14T	2 400 m ³ /h	300 Pa	1 410 rpm	400 V	1,1 A	0,37 kW	60 dB(A)	23,0 kg	43534405
ROOF-H/35/34/14T	3 400 m ³ /h	385 Pa	1 420 rpm	400 V	1,6 A	0,55 kW	63 dB(A)	31,0 kg	43534410
ROOF-H/40/50/14T	5 000 m ³ /h	490 Pa	1 430 rpm	400 V	2,1 A	0,75 kW	66 dB(A)	36,0 kg	43534415
ROOF-H/45/71/14T	7 100 m ³ /h	620 Pa	1 430 rpm	400 V	2,5 A	1,1 kW	69 dB(A)	55,0 kg	43534420
ROOF-H/50/97/14T	9 700 m ³ /h	765 Pa	1 450 rpm	400 V	4,6 A	2,2 kW	73 dB(A)	73,0 kg	43534425
ROOF-H/56/136/14T	13 600 m ³ /h	950 Pa	1 460 rpm	400 V	6,7 A	3,0 kW	76 dB(A)	76,0 kg	43534430
THREE-PHASE, 6-POLE MOTORS									
ROOF-H/25/08/09T	800 m ³ /h	80 Pa	870 rpm	400 V	0,65 A	0,12 kW	52 dB(A)	17,0 kg	43534397
ROOF-H/28/11/09T	1 100 m ³ /h	105 Pa	870 rpm	400 V	0,65 A	0,12 kW	54 dB(A)	17,0 kg	43534402
ROOF-H/31/16/09T	1 600 m ³ /h	130 Pa	870 rpm	400 V	0,65 A	0,12 kW	57 dB(A)	19,0 kg	43534407
ROOF-H/35/22/09T	2 250 m ³ /h	170 Pa	900 rpm	400 V	0,7 A	0,18 kW	60 dB(A)	27,0 kg	43534412
ROOF-H/40/32/09T	3 200 m ³ /h	215 Pa	880 rpm	400 V	1,0 A	0,25 kW	63 dB(A)	31,0 kg	43534417
ROOF-H/45/47/09T	4 700 m ³ /h	270 Pa	880 rpm	400 V	1,3 A	0,37 kW	66 dB(A)	44,0 kg	43534422
ROOF-H/50/64/09T	6 400 m ³ /h	340 Pa	940 rpm	400 V	2,0 A	0,75 kW	69 dB(A)	56,0 kg	43534427
ROOF-H/56/90/09T	9 000 m ³ /h	430 Pa	940 rpm	400 V	2,8 A	1,1 kW	73 dB(A)	64,0 kg	43534432
ROOF-H/63/129/09T	12 900 m ³ /h	540 Pa	965 rpm	400 V	5,0 A	2,2 kW	74 dB(A)	105,0 kg	43534437
ROOF-H/71/184/09T	18 400 m ³ /h	690 Pa	965 rpm	400 V	6,2 A	3,0 kW	81 dB(A)	147,0 kg	43534442
ROOF-H/80/264/09T	26 400 m ³ /h	840 Pa	960 rpm	400 V	13,3 A	5,5 kW	85 dB(A)	190,0 kg	43534447

* Measurement made at a distance of 1.5m from the outlet, for $Q = 2/3 * Q_{max}$
 ** value of the rated current may vary depending on the manufacturer of the electric motor used.



PERFORMANCE CHARACTERISTICS OF THE FANS

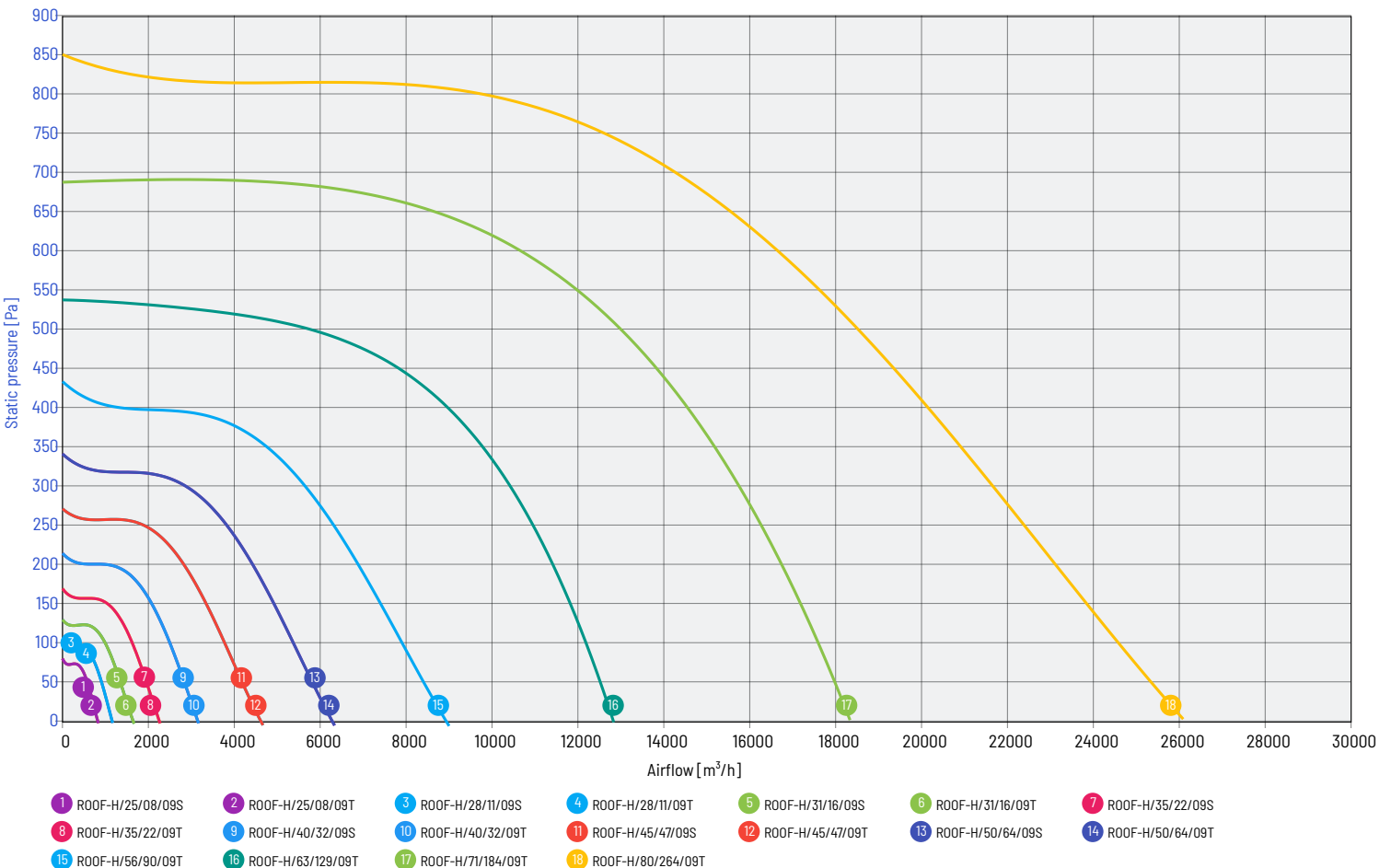
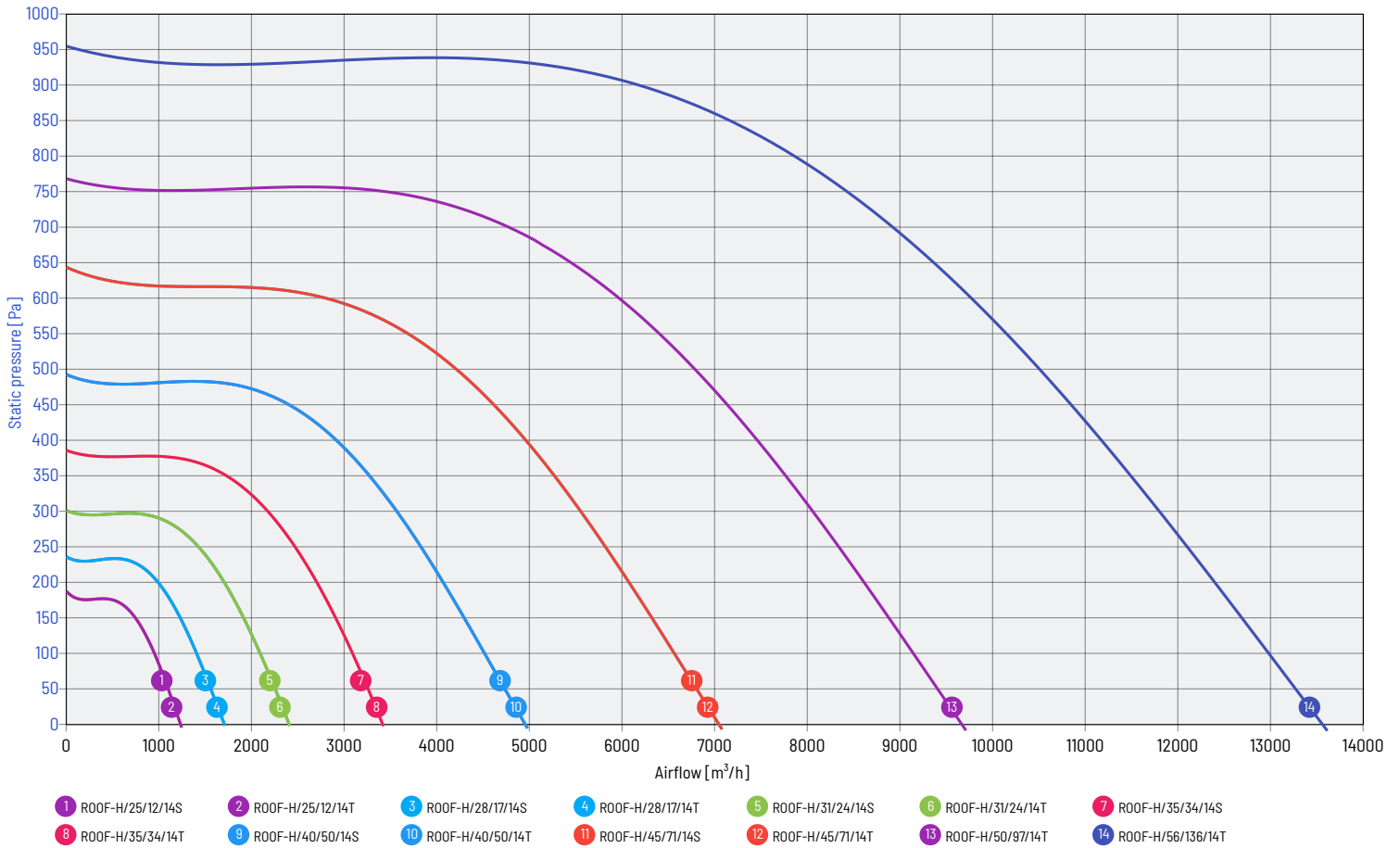



PERFORMANCE CHARACTERISTICS OF THE FANS

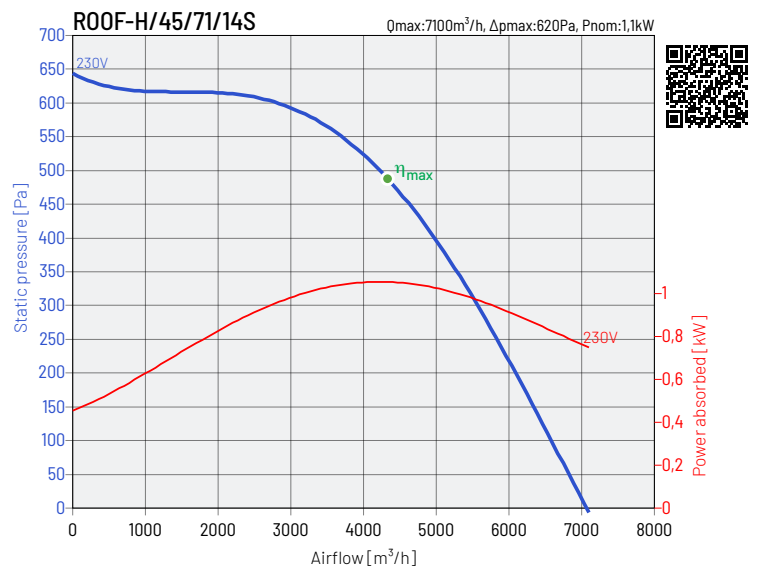
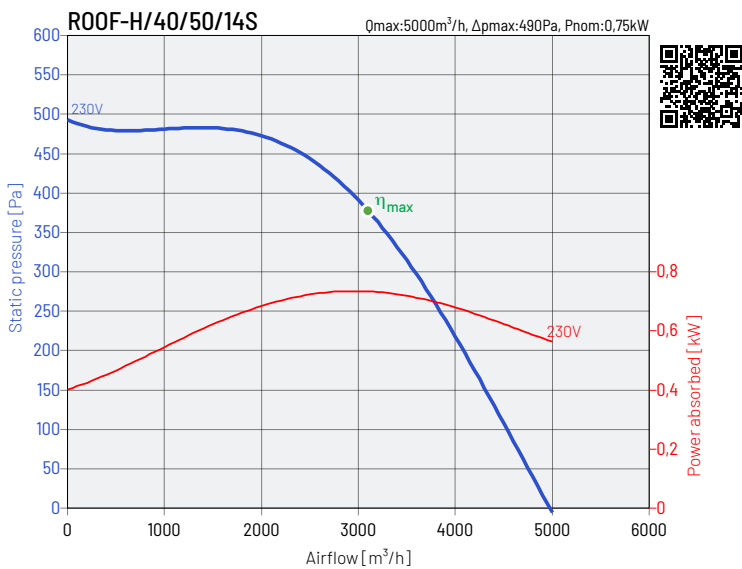
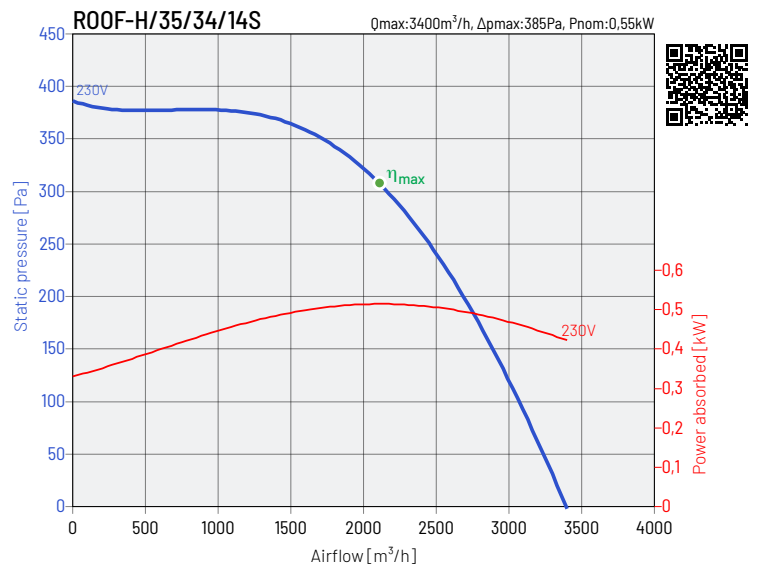
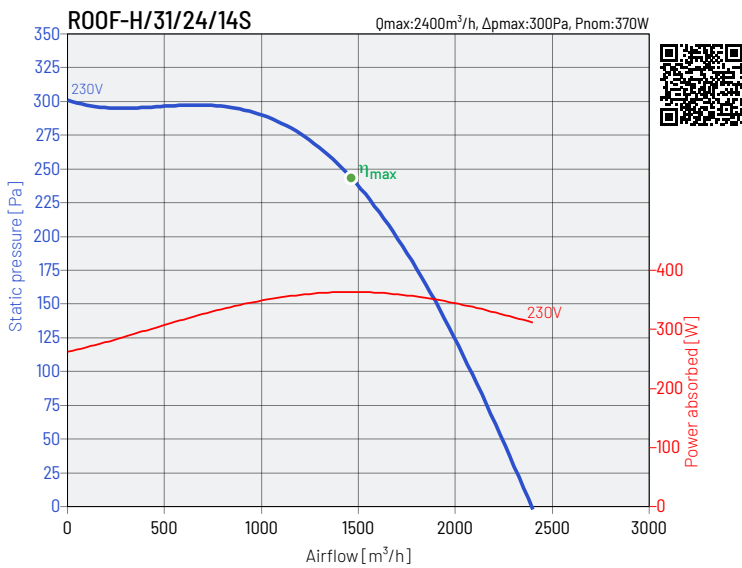
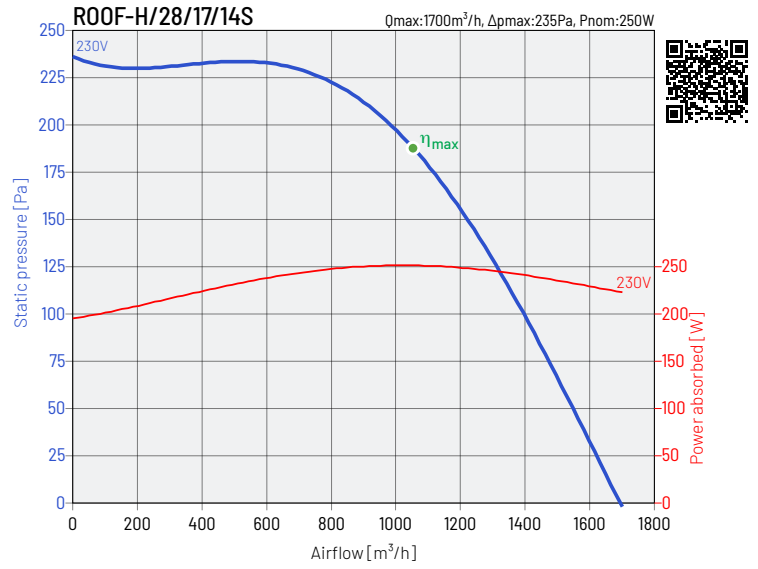
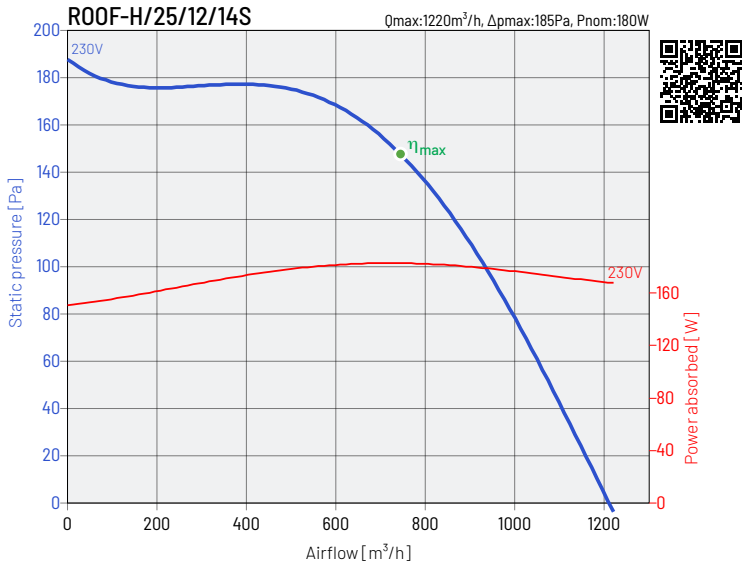

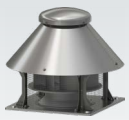

PERFORMANCE CHARACTERISTICS OF THE FANS

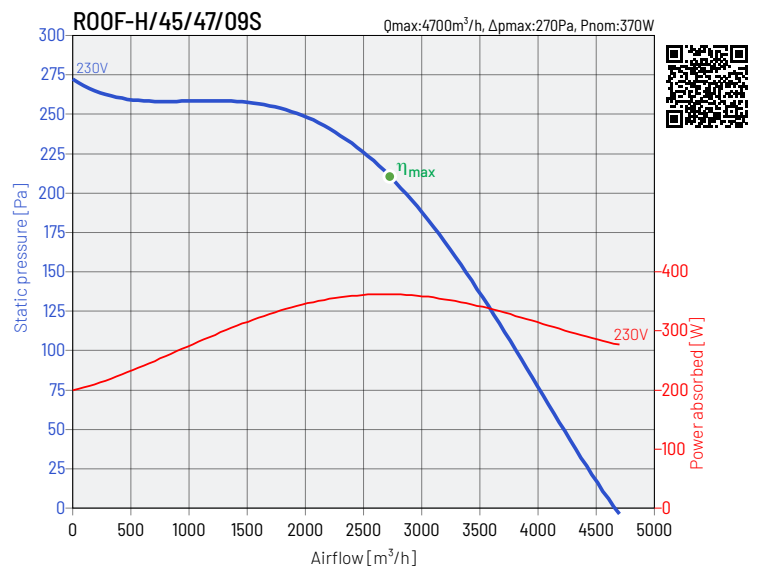
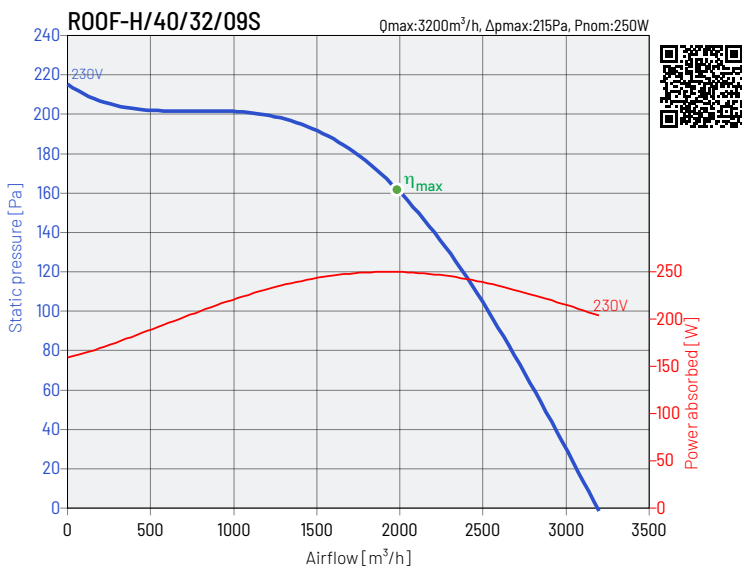
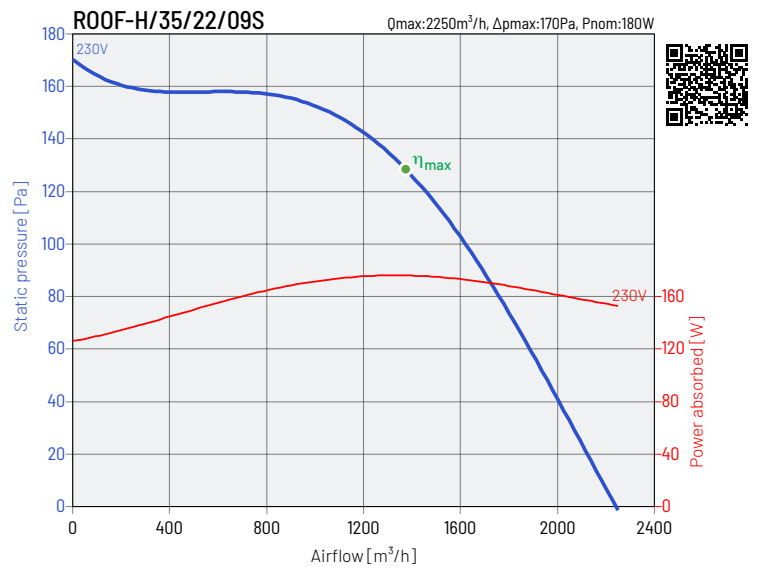
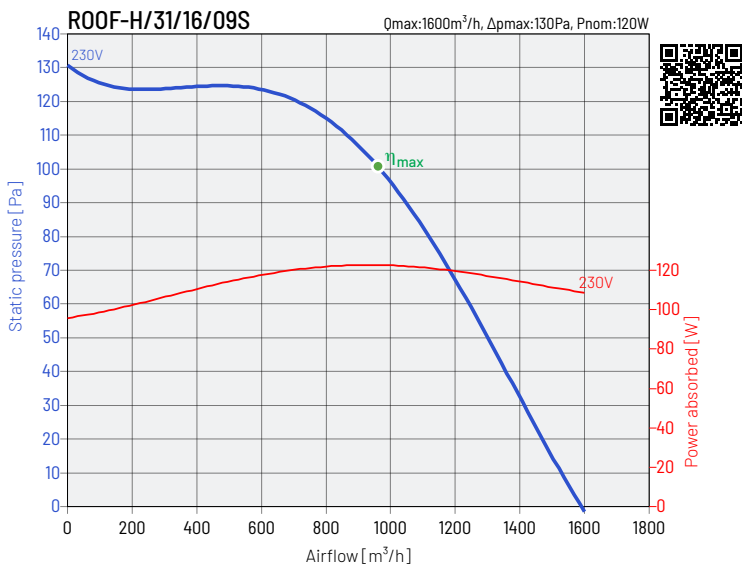
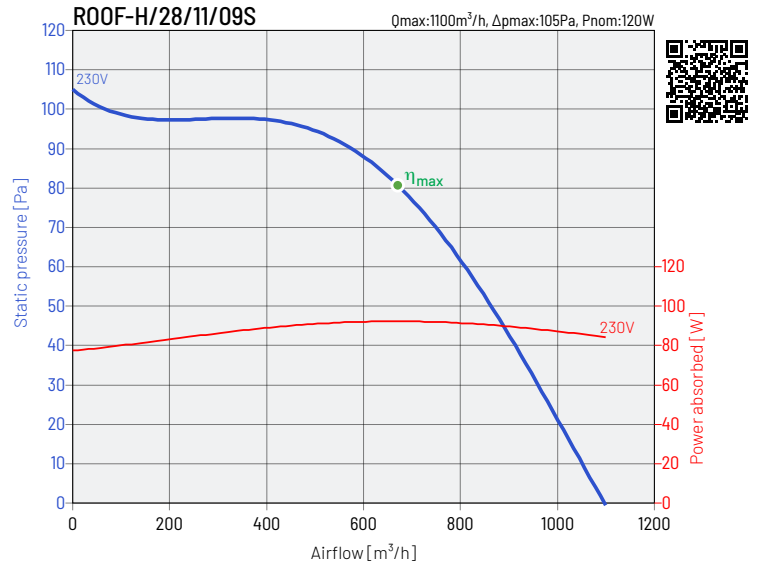
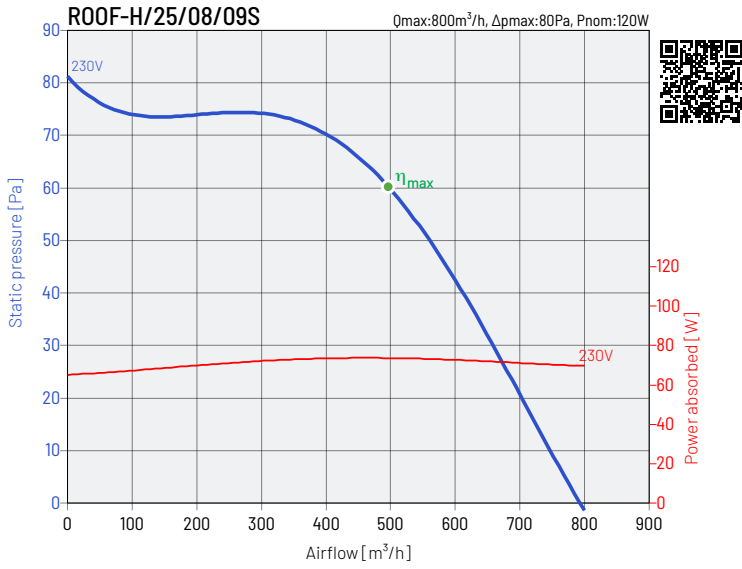



PERFORMANCE CHARACTERISTICS OF THE FANS

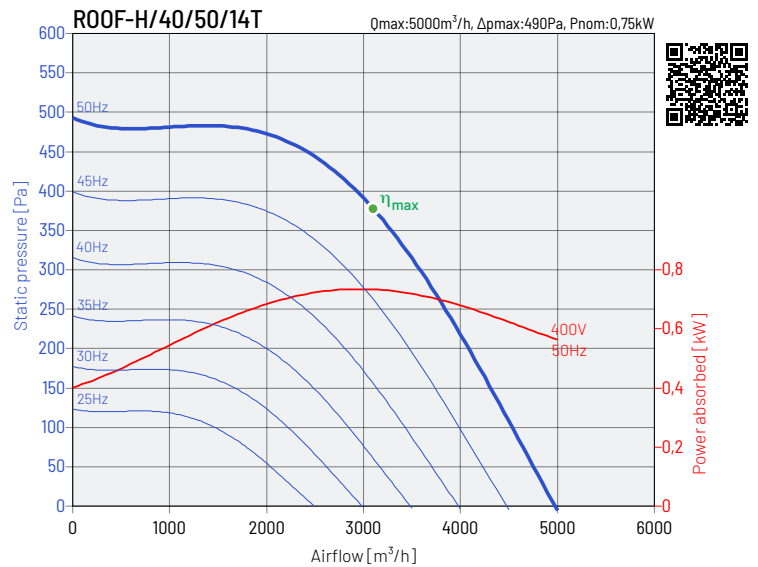
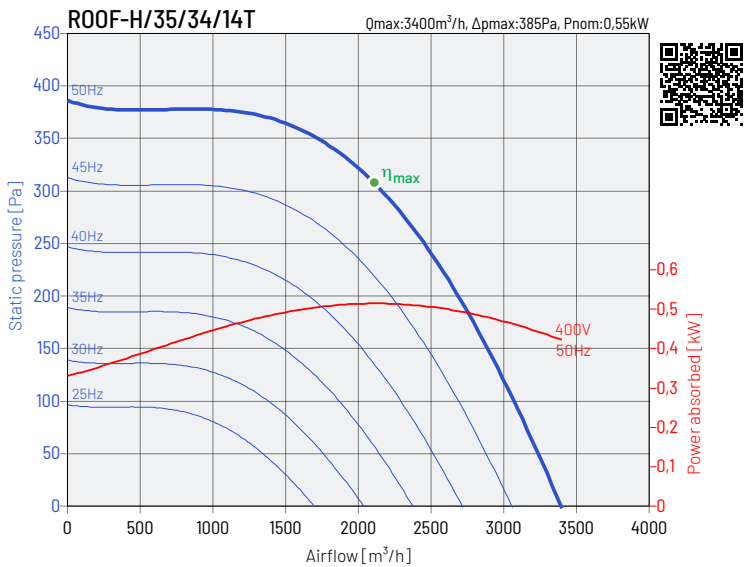
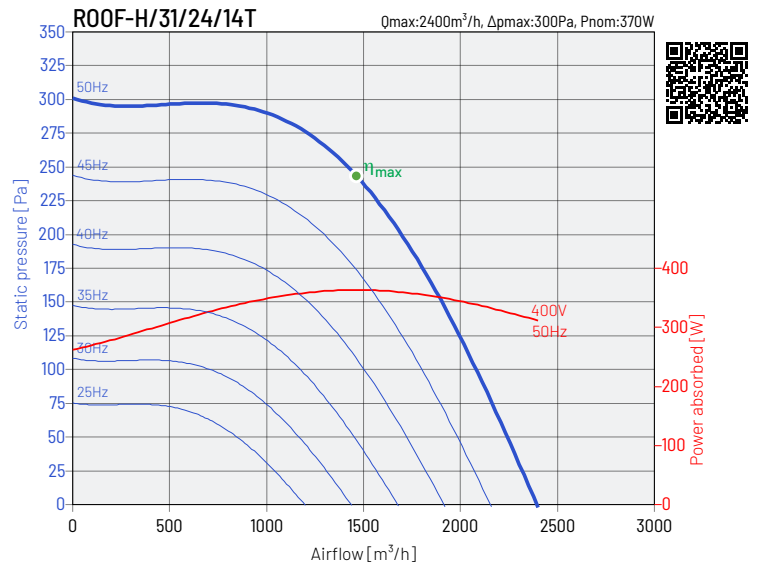
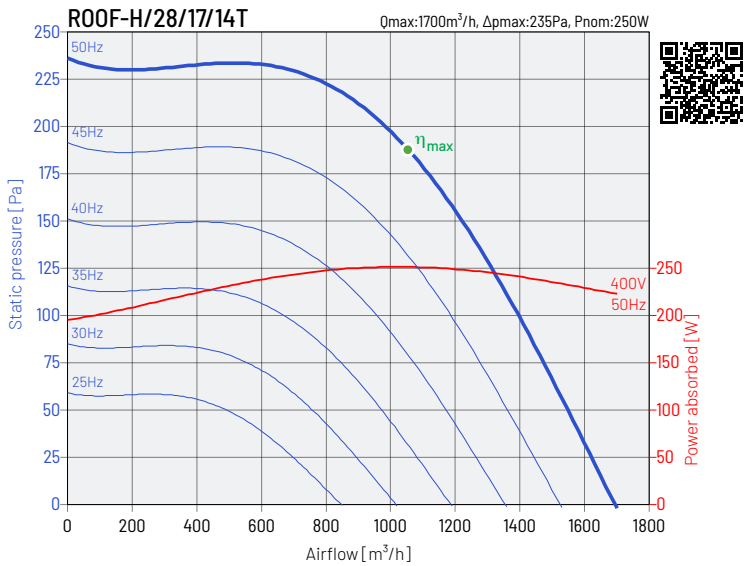
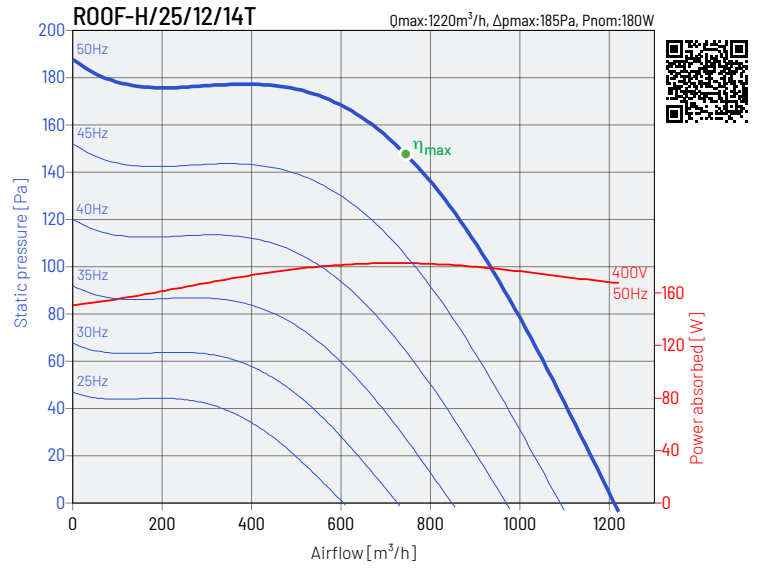
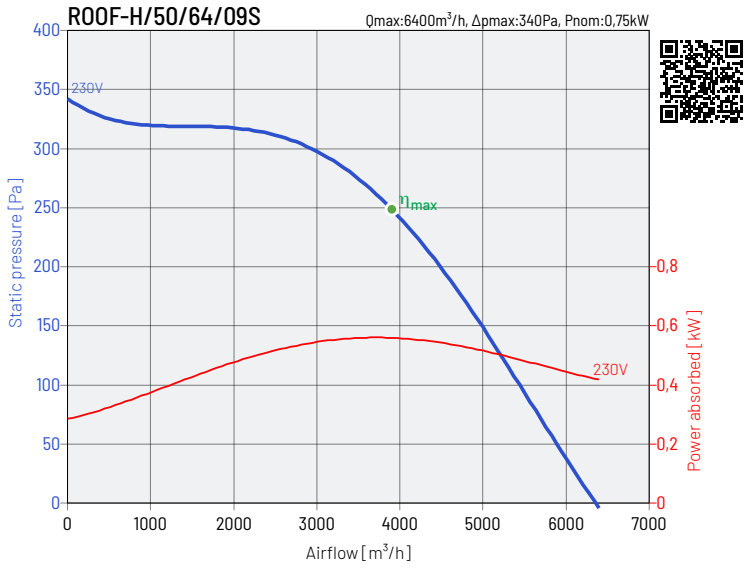



PERFORMANCE CHARACTERISTICS OF THE FANS

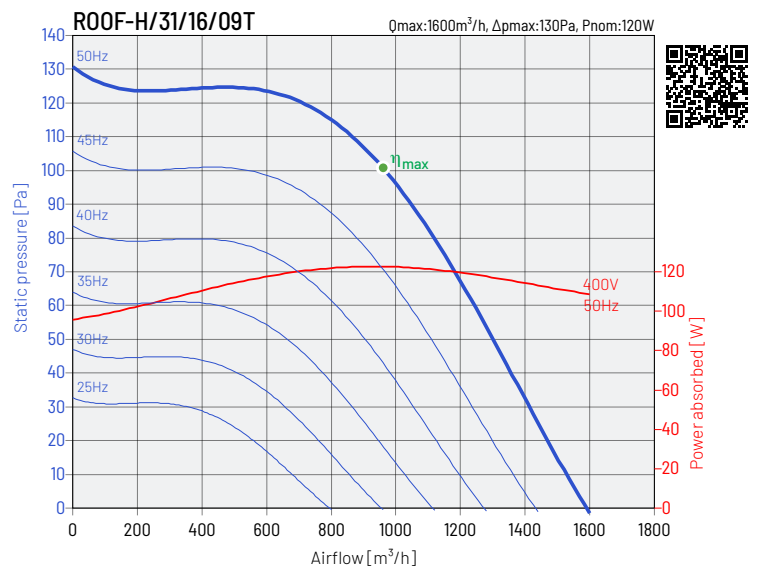
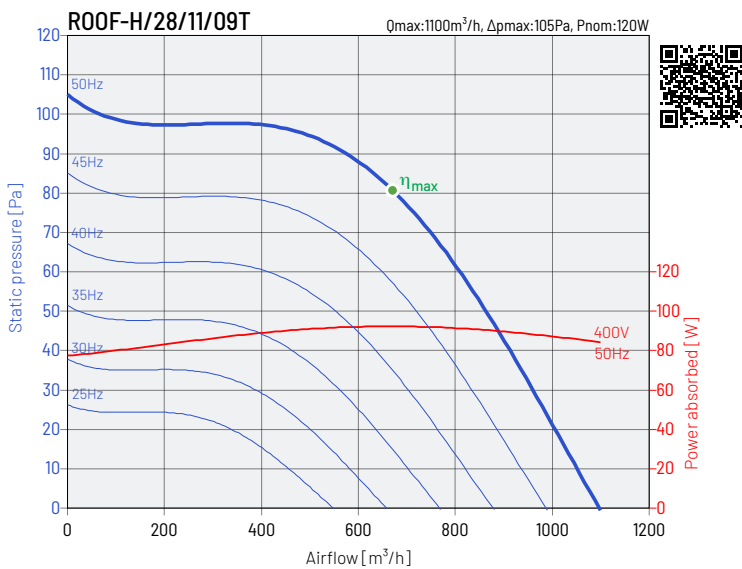
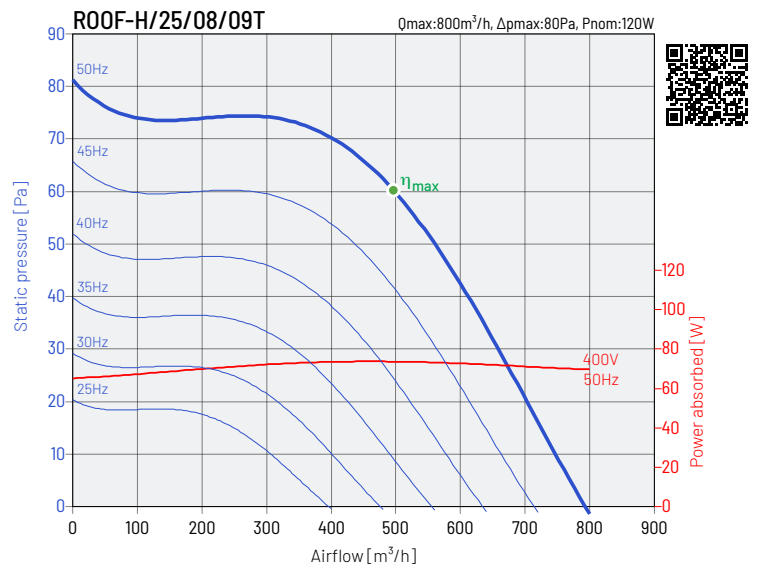
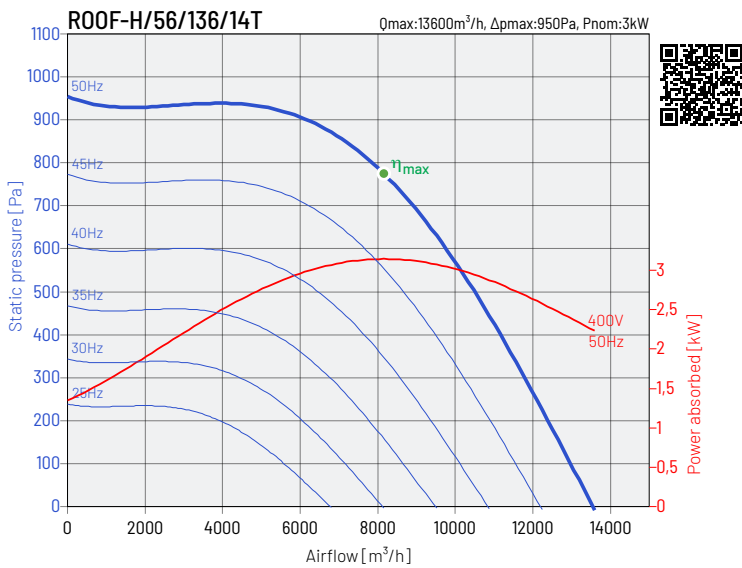
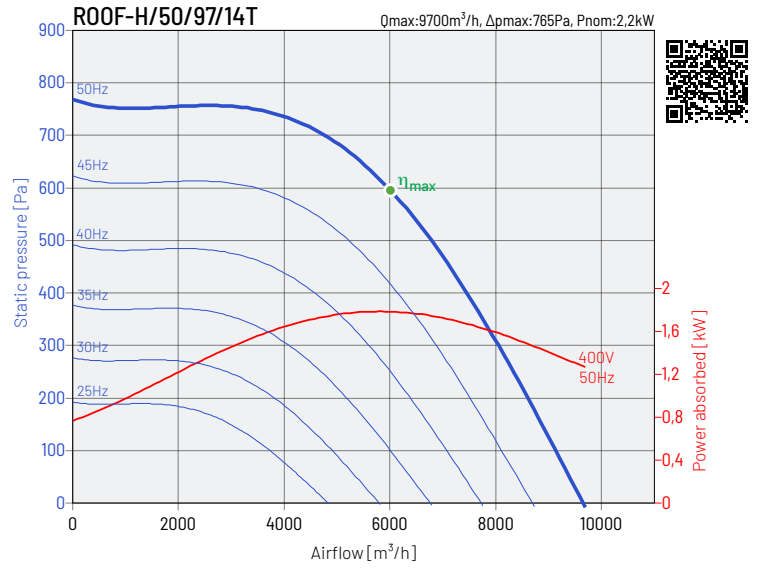
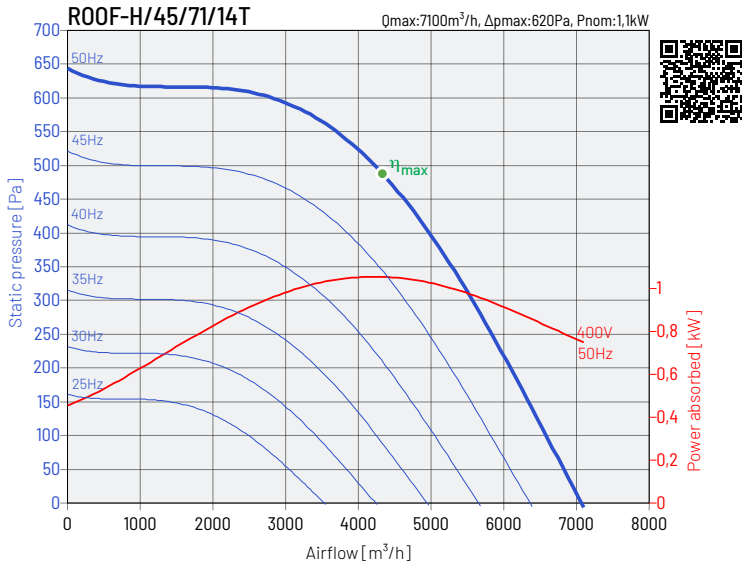



PERFORMANCE CHARACTERISTICS OF THE FANS

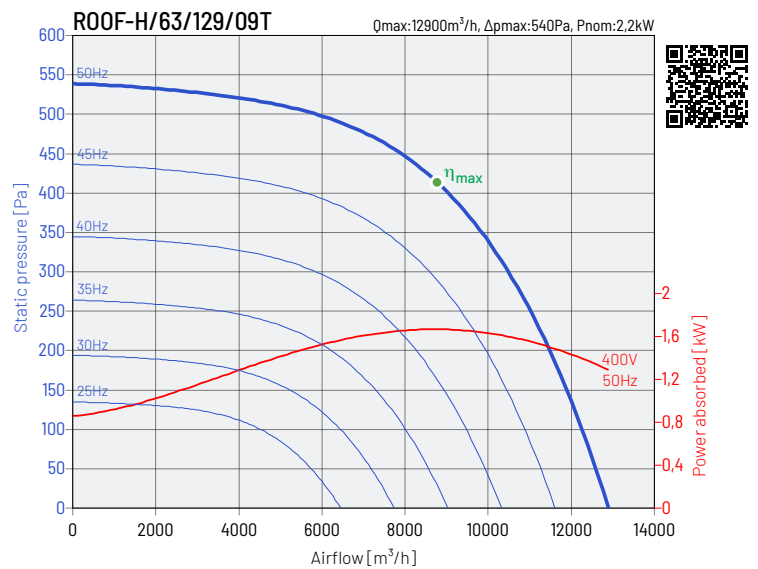
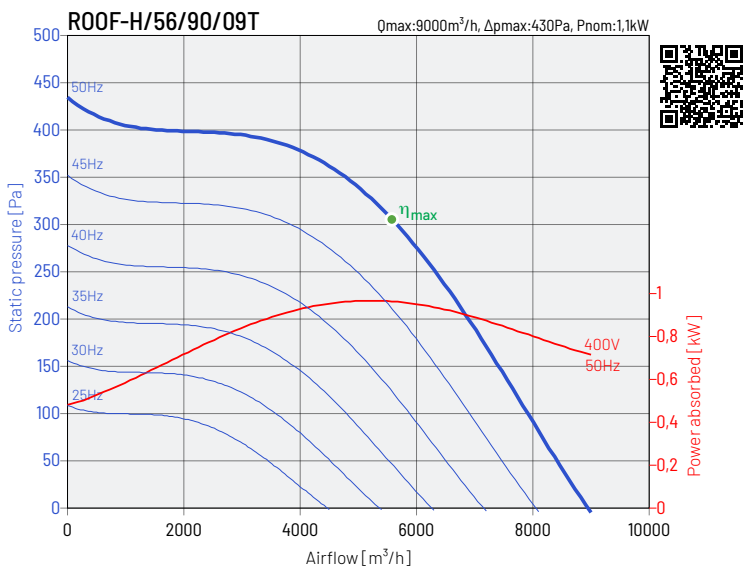
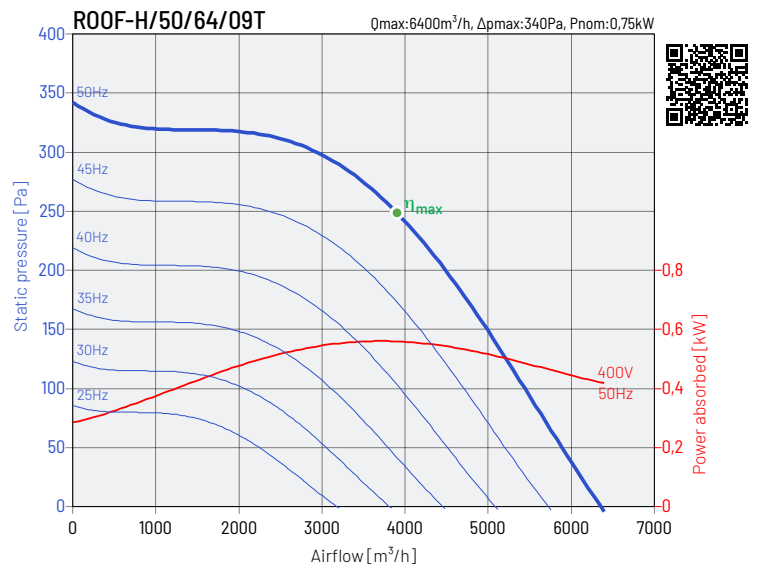
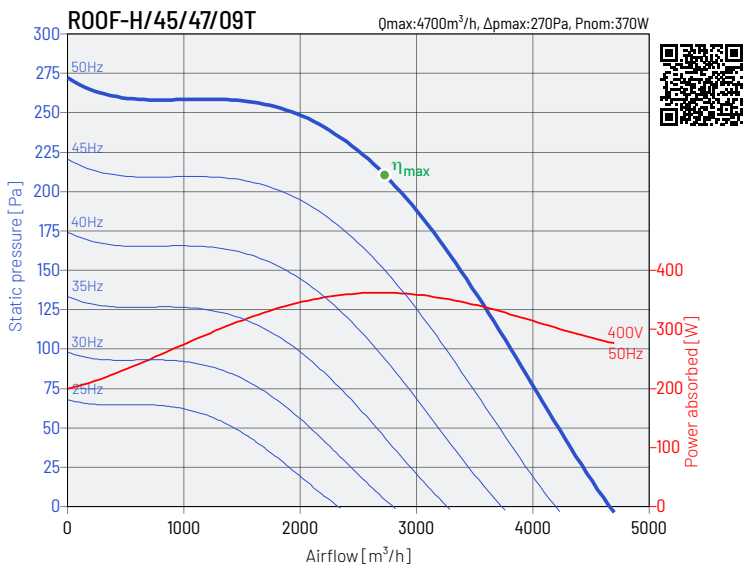
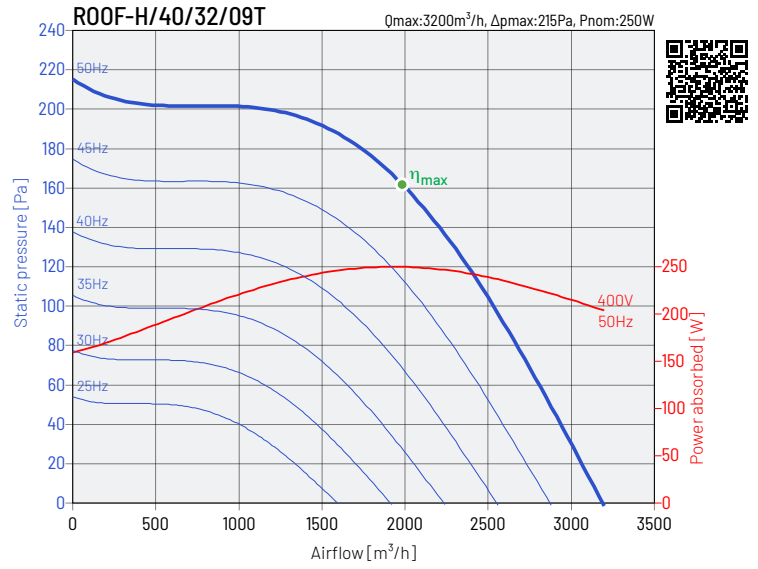
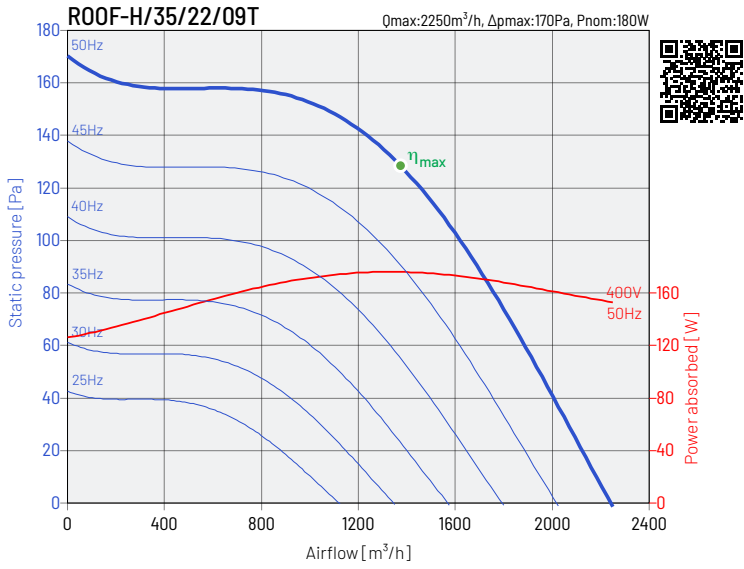

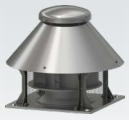

PERFORMANCE CHARACTERISTICS OF THE FANS

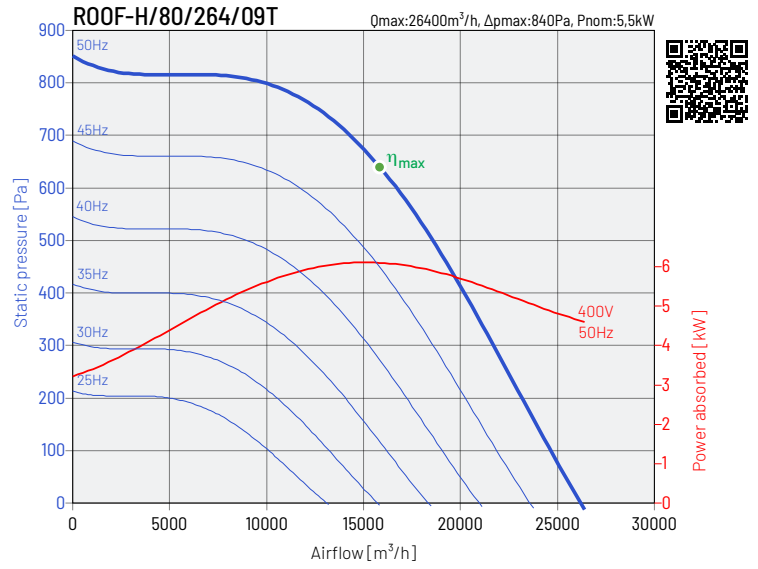
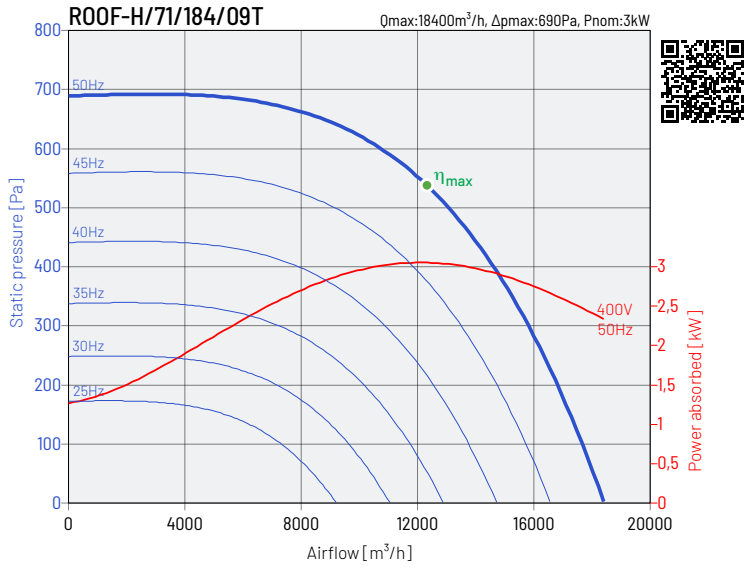



ROOF-H Roof fan

The power of AIR



DIMENSIONS

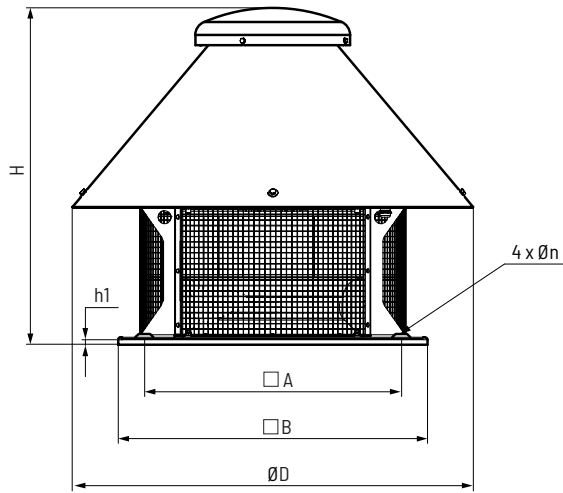

type	A mm	B mm	ØD mm	H mm	h1 mm	Øn mm
ROOF-H/25	330	435	510	456	15	12
ROOF-H/28	330	435	510	456	15	12
ROOF-H/31	330	435	570	471	15	12
ROOF-H/35	450	560	680	606	15	12
ROOF-H/40	450	560	730	623	15	12
ROOF-H/45	535	630	800	666	15	12
ROOF-H/50	590	710	920	773	17	12
ROOF-H/56	590	710	1000	762	17	12
ROOF-H/63	750	900	1115	935	40	14
ROOF-H/71	750	900	1250	1060	40	14
ROOF-H/80	840	1100	1410	1185	40	14



MOUNTING ACCESSORIES

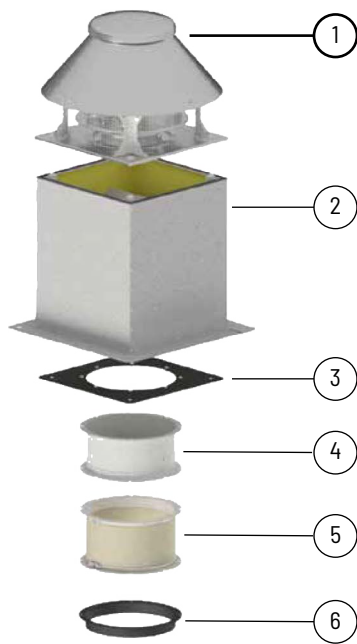

type	flat roof up RSS	flat roof up RS	flat roof up RS-I	flat roof up RSA	flat roof up RSA-I
ROOF-H/25	RSS 435	RS 435	RS-I 435	RSA 435	RSA-I 435
ROOF-H/28	RSS 435	RS 435	RS-I 435	RSA 435	RSA-I 435
ROOF-H/31	RSS 435	RS 435	RS-I 435	RSA 435	RSA-I 435
ROOF-H/35	RSS 560	RS 560	RS-I 560	RSA 560	RSA-I 560
ROOF-H/40	RSS 560	RS 560	RS-I 560	RSA 560	RSA-I 560
ROOF-H/45	RSS 630	RS 630	RS-I 630	RSA 630	RSA-I 630
ROOF-H/50	RSS 710	RS 710	RS-I 710	RSA 710	RSA-I 710
ROOF-H/56	RSS 710	RS 710	RS-I 710	RSA 710	RSA-I 710
ROOF-H/63	RSS 905	RS 905	RS-I 905	RSA 905	RSA-I 905
ROOF-H/71	RSS 905	RS 905	RS-I 905	RSA 905	RSA-I 905
ROOF-H/80	RSS 1100	RS 1100	RS-I 1100	RSA 1100	RSA-I 1100



type	mounting plate P	backflow preventer KZD SE	connector anti-vibration ZDPO	stub-pipe K
ROOF-H/25	P 435	KZD SE 435	ZDPO 435	K 435
ROOF-H/28	P 435	KZD SE 435	ZDPO 435	K 435
ROOF-H/31	P 435	KZD SE 435	ZDPO 435	K 435
ROOF-H/35	P 560	KZD SE 560	ZDPO 560	K 560
ROOF-H/40	P 560	KZD SE 560	ZDPO 560	K 560
ROOF-H/45	P 630	KZD SE 630	ZDPO 630	K 630
ROOF-H/50	P 710	KZD SE 710	ZDPO 710	K 710
ROOF-H/56	P 710	KZD SE 710	ZDPO 710	K 710
ROOF-H/63	P 905	KZD SE 905	ZDPO 905	K 905
ROOF-H/71	P 905	KZD SE 905	ZDPO 905	K 905
ROOF-H/80	P 1100	KZD SE 1100	ZDPO 1100	K 1100

Article numbers

43526520	RSS 435	43526020	RS 435	43526120	RSA 435	43526310	P 435	43527410	ZDPO 435	43526410	K 435
43526530	RSS 560	43526030	RS 560	43526130	RSA 560	43526320	P 560	43527420	ZDPO 560	43526420	K 560
43526540	RSS 630	43526040	RS 630	43526140	RSA 630	43526330	P 630	43527430	ZDPO 630	43526430	K 630
43526550	RSS 710	43526050	RS 710	43526150	RSA 710	43526340	P 710	43527440	ZDPO 710	43526440	K 710
43526560	RSS 905	43526060	RS 905	43526160	RSA 905	43526350	P 905	43527450	ZDPO 905	43526450	K 905
43526570	RSS 1100	43526070	RS 1100	43526170	RSA 1100	43526360	P 1100	43527460	ZDPO 1100	43526460	K 1100
43526580	RSS 1250	43526080	RS 1250	43526180	RSA 1250	43526370	P 1250	43527470	ZDPO 1250	43526470	K 1250
		43526721	RS-I 435	43526821	RSA-I 435	43527312	KZD SE 435				
		43526731	RS-I 560	43526831	RSA-I 560	43527322	KZD SE 560				
		43526741	RS-I 630	43526841	RSA-I 630	43527332	KZD SE 630				
		43526751	RS-I 710	43526851	RSA-I 710	43527342	KZD SE 710				
		43526761	RS-I 905	43526861	RSA-I 905	43527352	KZD SE 905				
		43526771	RS-I 1100	43526871	RSA-I 1100	43527362	KZD SE 1100				
		43526781	RS-I 1250	43526881	RSA-I 1250	43527372	KZD SE 1250				



ELECTRICAL ACCESSORIES



type	wall thermostat	duct thermostat	sensor temperature	air quality sensor	humidistat	thyristor controller
	TS*	TK-21	for TK-21	SQA	HIG-2	REB
ROOF-H/25/12/14S	TS	TK-21	Sensor TK-21	SQA	HIG-2	REB-5
ROOF-H/28/17/14S	TS	TK-21	Sensor TK-21	SQA + DILM7-10	HIG-2 + DILM7-10	REB-5
ROOF-H/31/24/14S	TS + DILM7-10	TK-21	Sensor TK-21	SQA + DILM7-10	HIG-2 + DILM7-10	REB-5
ROOF-H/35/34/14S	TS + DILM7-10	TK-21 + DILM7-10	Sensor TK-21	SQA + DILM7-10	HIG-2 + DILM7-10	REB-10
ROOF-H/40/50/14S	TS + DILM7-10	TK-21 + DILM7-10	Sensor TK-21	SQA + DILM7-10	HIG-2 + DILM7-10	REB-10
ROOF-H/45/71/14S	TS + DILM7-10	TK-21 + DILM7-10	Sensor TK-21	SQA + DILM7-10	HIG-2 + DILM7-10	REB-10
ROOF-H/25/08/09S	TS	TK-21	Sensor TK-21	SQA	HIG-2	REB-5
ROOF-H/28/11/09S	TS	TK-21	Sensor TK-21	SQA	HIG-2	REB-5
ROOF-H/31/16/09S	TS	TK-21	Sensor TK-21	SQA	HIG-2	REB-5
ROOF-H/35/22/09S	TS	TK-21	Sensor TK-21	SQA	HIG-2	REB-5
ROOF-H/40/32/09S	TS	TK-21	Sensor TK-21	SQA + DILM7-10	HIG-2 + DILM7-10	REB-5
ROOF-H/45/47/09S	TS + DILM7-10	TK-21	Sensor TK-21	SQA + DILM7-10	HIG-2 + DILM7-10	REB-10
ROOF-H/50/64/09S	TS + DILM7-10	TK-21 + DILM7-10	Sensor TK-21	SQA + DILM7-10	HIG-2 + DILM7-10	REB-10
ROOF-H/25/12/14T	TS + DILM7-10	TK-21 + DILM7-10	Sensor TK-21	SQA + DILM7-10	HIG-2 + DILM7-10	-
ROOF-H/28/16/14T	TS + DILM7-10	TK-21 + DILM7-10	Sensor TK-21	SQA + DILM7-10	HIG-2 + DILM7-10	-
ROOF-H/31/23/14T	TS + DILM7-10	TK-21 + DILM7-10	Sensor TK-21	SQA + DILM7-10	HIG-2 + DILM7-10	-
ROOF-H/35/33/14T	TS + DILM7-10	TK-21 + DILM7-10	Sensor TK-21	SQA + DILM7-10	HIG-2 + DILM7-10	-
ROOF-H/40/48/14T	TS + DILM7-10	TK-21 + DILM7-10	Sensor TK-21	SQA + DILM7-10	HIG-2 + DILM7-10	-
ROOF-H/45/68/14T	TS + DILM7-10	TK-21 + DILM7-10	Sensor TK-21	SQA + DILM7-10	HIG-2 + DILM7-10	-
ROOF-H/50/93/14T	TS + DILM7-10	TK-21 + DILM7-10	Sensor TK-21	SQA + DILM7-10	HIG-2 + DILM7-10	-
ROOF-H/56/130/14T	TS + DILM7-10	TK-21 + DILM7-10	Sensor TK-21	SQA + DILM7-10	HIG-2 + DILM7-10	-
ROOF-H/25/08/09T	TS + DILM7-10	TK-21 + DILM7-10	Sensor TK-21	SQA + DILM7-10	HIG-2 + DILM7-10	-
ROOF-H/28/11/09T	TS + DILM7-10	TK-21 + DILM7-10	Sensor TK-21	SQA + DILM7-10	HIG-2 + DILM7-10	-
ROOF-H/31/16/09T	TS + DILM7-10	TK-21 + DILM7-10	Sensor TK-21	SQA + DILM7-10	HIG-2 + DILM7-10	-
ROOF-H/35/21/09T	TS + DILM7-10	TK-21 + DILM7-10	Sensor TK-21	SQA + DILM7-10	HIG-2 + DILM7-10	-
ROOF-H/40/31/09T	TS + DILM7-10	TK-21 + DILM7-10	Sensor TK-21	SQA + DILM7-10	HIG-2 + DILM7-10	-
ROOF-H/45/46/09T	TS + DILM7-10	TK-21 + DILM7-10	Sensor TK-21	SQA + DILM7-10	HIG-2 + DILM7-10	-
ROOF-H/50/62/09T	TS + DILM7-10	TK-21 + DILM7-10	Sensor TK-21	SQA + DILM7-10	HIG-2 + DILM7-10	-
ROOF-H/56/88/09T	TS + DILM7-10	TK-21 + DILM7-10	Sensor TK-21	SQA + DILM7-10	HIG-2 + DILM7-10	-
ROOF-H/63/125/09T	TS + DILM7-10	TK-21 + DILM7-10	Sensor TK-21	SQA + DILM7-10	HIG-2 + DILM7-10	-
ROOF-H/71/178/09T	TS + DILM7-10	TK-21 + DILM7-10	Sensor TK-21	SQA + DILM7-10	HIG-2 + DILM7-10	-
ROOF-H/80/256/09T	TS + DILM15-10	TK-21 + DILM15-10	Sensor TK-21	SQA + DILM15-10	HIG-2 + DILM15-10	-

* single phase motor use all tracks in the contactor

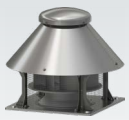

ELECTRICAL ACCESSORIES



type	11-speed thyristor controller	transformer regulator		transformer regulator 2-adjustable	inverter
	IRF	RMB	RVS	SC2A	L
ROOF-H/25/12/14S	IRF-900	RMB 3,5	RVS 3	SC2A1-25L25	-
ROOF-H/28/17/14S	IRF-900	RMB 3,5	RVS 3	SC2A1-25L25	-
ROOF-H/31/24/14S	IRF-900	RMB 3,5	RVS 5	SC2A1-35L25	-
ROOF-H/35/34/14S	IRF-900	RMB 8	RVS 5	SC2A1-50L25	-
ROOF-H/40/50/14S	IRF-900	RMB 8	RVS 5	SC2A1-50L25	-
ROOF-H/45/71/14S	-	RMB 10	RVS 10	SC2A1-110L25	-
ROOF-H/25/08/09S	IRF-900	RMB 3,5	RVS 3	SC2A1-25L25	-
ROOF-H/28/11/09S	IRF-900	RMB 3,5	RVS 3	SC2A1-25L25	-
ROOF-H/31/16/09S	IRF-900	RMB 3,5	RVS 3	SC2A1-25L25	-
ROOF-H/35/22/09S	IRF-900	RMB 3,5	RVS 3	SC2A1-25L25	-
ROOF-H/40/32/09S	IRF-900	RMB 3,5	RVS 3	SC2A1-25L25	-
ROOF-H/45/47/09S	IRF-900	RMB 3,5	RVS 5	SC2A1-50L25	-
ROOF-H/50/64/09S	IRF-900	RMB 8	RVS 7	SC2A1-75L25	-
ROOF-H/25/12/14T	-	-	-	SC2A4-15L55	L 0.4kW
ROOF-H/28/16/14T	-	-	-	SC2A4-15L55	L 0.4kW
ROOF-H/31/23/14T	-	-	-	SC2A4-15L55	L 0.4kW
ROOF-H/35/33/14T	-	-	-	SC2A4-25L55	L 0.75kW
ROOF-H/40/48/14T	-	-	-	SC2A4-25L55	L 0.75kW
ROOF-H/45/68/14T	-	-	-	SC2A4-40L55	L 1.5kW
ROOF-H/50/93/14T	-	-	-	SC2A4-60L55	L 2.2kW
ROOF-H/56/130/14T	-	-	-	SC2A4-80L55	L 4.0kW
ROOF-H/25/08/09T	-	-	-	SC2A4-15L55	L 0.4kW
ROOF-H/28/11/09T	-	-	-	SC2A4-15L55	L 0.4kW
ROOF-H/31/16/09T	-	-	-	SC2A4-15L55	L 0.4kW
ROOF-H/35/21/09T	-	-	-	SC2A4-15L55	L 0.4kW
ROOF-H/40/31/09T	-	-	-	SC2A4-15L55	L 0.4kW
ROOF-H/45/46/09T	-	-	-	SC2A4-15L55	L 0.4kW
ROOF-H/50/62/09T	-	-	-	SC2A4-25L55	L 0.75kW
ROOF-H/56/88/09T	-	-	-	SC2A4-40L55	L 1.5kW
ROOF-H/63/125/09T	-	-	-	SC2A4-40L55	L 2.2kW
ROOF-H/71/178/09T	-	-	-	SC2A4-80L55	L 4.0kW
ROOF-H/80/256/09T	-	-	-	-	L 5.5kW

Article numbers

91040997 DILM7-10	40025345 TS	40025051 REB-5	40025234 RVS 3	40025253 SC2A1-25L25	40016302 L 0.4kW
91040666-42 DILM15-10	40025320 TK-21	40025055 REB-10	40025235 RVS 5	40025255 SC2A1-35L25	40016312 L 0.75kW
91040905 DILM25-10	40025140 SQA	40015154 IRF-900	40025236 RVS 7	40025257 SC2A1-50L25	40016322 L 1.5kW
91040666 DILM40-10	40025150 HIG-2	40025070 RMB 3,5	40025237 RVS 10	40025259 SC2A1-75L25	40016332 L 2.2kW
		40025080 RMB 8		40025251 SC2A1-110L25	40016352 L 4.0kW
		40025090 RMB 10		40025270 SC2A4-15L55	40016362 L 5.5kW
				40025272 SC2A4-25L55	40016383 L 11kW
				40025274 SC2A4-40L55	40016412 L 18.5kW
				40025276 SC2A4-60L55	
				40025278 SC2A4-80L55	