



ZASTOSOWANIE

Wentylator przeznaczony do wszelkiego rodzaju instalacji wentylacji ogólnej. Typowe zastosowania to:

- wentylacja wywiewna i nawiewna mieszkań, biur, sklepów, lokali gastronomicznych.

KONSTRUKCJA

- obudowa z ocynkowanej blachy stalowej,
- skrzynka przyłączeniowa na obudowie,
- wspornik montażowy w standardzie,
- wirnik, łopatki kierujące i dyfuzor wylotu, wykonane z formowanego wtryskowo tworzywa sztucznego,
- uszczelka na wlocie i wylocie,
- Silent-block pomiędzy silnikiem a wspornikiem.

SILNIK ELEKTRYCZNY

- silnik EC 230V ± 10% 50 / 60Hz,
- stopień izolacji IP44,
- regulacja za pomocą potencjometru w puszcze przyłączeniowej lub za pomocą sygnału zewnętrznego 0-10V,
- zabezpieczenie termiczne z ręcznym resetem.



DANE TECHNICZNE

Typ	wydajność max [m³/h]	sygnał wejściowy [V]	prędkość obrotowa [obr/min]	napięcie [V]	natężenie [A]	pobór mocy max. [W]	poziom ciśnienia akustycznego*			temperatura pracy		masa [kg]	nr. artykułu
							wlot	wylot	emit.	min	max		
							[dB(A)]			[°C]			
JETLINE-100 ECOWATT	260	10	2650	230	0,1	16	41	41	20	-20	+40	2,5	40021957
	220	8	2250		0,1	11	38	37	17				
	180	6	1750		0,1	7	32	32	11				
	120	4	1230		0,1	4	25	24	6				
JETLINE-125 ECOWATT	390	10	2650	230	0,2	26	45	45	26	-20	+40	2,8	40021958
	330	8	2240		0,1	17	41	42	22				
	260	6	1730		0,1	9	36	36	17				
JETLINE-150 ECOWATT	680	10	2650	230	0,5	58	51	51	33	-20	+40	3,6	40021959
	580	8	2260		0,3	36	48	48	29				
	450	6	1740		0,2	18	42	42	24				
	310	4	1240		0,1	8	35	35	16				
JETLINE-160 ECOWATT	720	10	2650	230	0,5	60	51	51	33	-20	+40	3,6	40021960
	610	8	2250		0,3	38	48	48	29				
	460	6	1730		0,2	19	42	42	24				
	330	4	1240		0,1	8	35	35	16				
JETLINE-200 ECOWATT	1050	10	2630	230	0,8	109	55	55	38	-20	+40	4,7	40021961
	890	8	2250		0,5	70	52	52	34				
	690	6	1760		0,2	35	46	46	29				
	490	4	1250		0,1	15	39	39	22				
JETLINE-250 ECOWATT	1270	10	2740	230	0,9	135	58	57	41	-20	+40	5,8	40021962
	1090	8	2350		0,7	96	55	54	38				
	820	6	1830		0,4	49	49	48	32				
	580	4	1290		0,2	22	42	41	24				
JETLINE-315 ECOWATT	1570	10	2640	230	1,3	194	61	60	45	-20	+40	8	40021963
	1360	8	2280		0,9	129	58	57	42				
	1070	6	1780		0,5	66	53	52	36				
	740	4	1260		0,2	33	45	44	29				

* pomiar wykonany w odległości 1,5m od wylotu, dla q=2/3 qmax

CHARAKTERYSTYKI PRACY

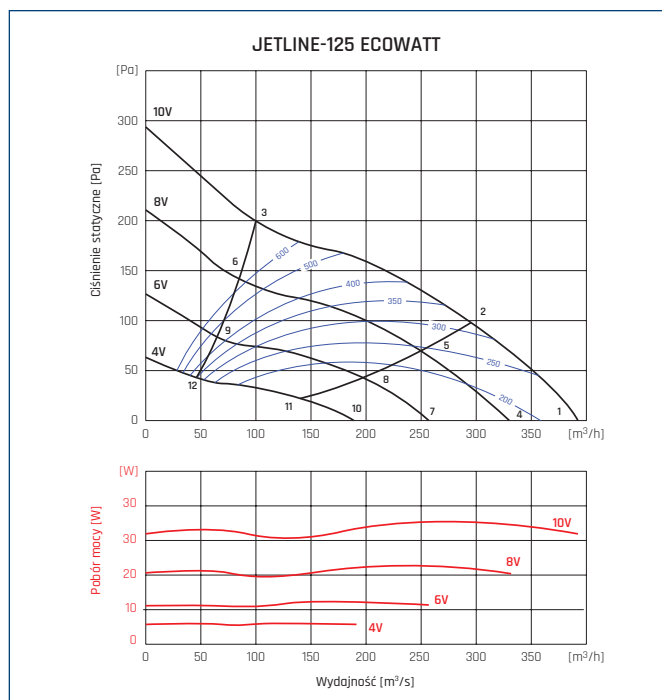
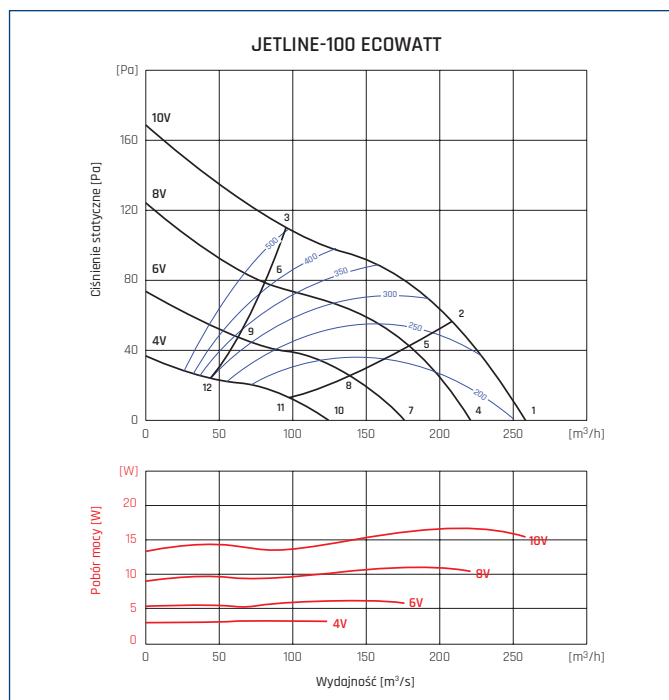

Częst. Hz/dB(A)		63	125	250	500	1000	2000	4000	8000	L _{WA}
1	Wlot	34	34	45	54	52	51	50	35	58
	Wylot	27	35	45	52	49	49	47	33	56
	Emitowany	24	15	20	29	31	31	32	19	37
2	Wlot	32	34	44	50	49	49	48	34	56
	Wylot	28	37	44	50	48	47	48	33	55
	Emitowany	22	14	19	25	28	29	30	18	35
3	Wlot	33	40	52	55	53	51	50	36	60
	Wylot	28	42	50	53	52	48	49	35	58
	Emitowany	23	20	27	29	32	30	31	20	38
4	Wlot	31	31	41	51	49	48	47	31	55
	Wylot	24	32	41	48	46	45	43	30	52
	Emitowany	21	12	17	25	28	28	29	16	34
5	Wlot	28	30	40	47	46	45	45	31	52
	Wylot	24	33	40	47	45	43	45	30	52
	Emitowany	18	1	16	21	24	25	27	14	31
6	Wlot	30	36	48	51	50	47	46	33	56
	Wylot	25	39	47	49	48	45	46	31	54
	Emitowany	19	17	24	25	28	27	28	16	34
7	Wlot	25	25	36	45	43	42	41	26	49
	Wylot	18	26	36	43	40	39	38	24	47
	Emitowany	15	6	1	20	22	22	23	10	28
8	Wlot	23	25	35	41	40	40	39	25	47
	Wylot	19	28	35	41	39	38	39	24	46
	Emitowany	13	5	10	16	19	20	21	9	26
9	Wlot	24	31	43	46	44	42	41	27	50
	Wylot	19	33	41	44	43	39	40	25	49
	Emitowany	14	1	18	20	23	21	22	1	28
10	Wlot	18	18	28	37	36	34	34	18	42
	Wylot	1	19	28	35	33	32	30	17	39
	Emitowany	8	2	4	12	15	15	16	3	21
11	Wlot	15	17	27	34	33	32	32	17	39
	Wylot	1	20	27	34	32	30	32	17	39
	Emitowany	5	2	2	8	1	12	14	1	18
12	Wlot	17	23	35	38	37	34	33	19	43
	Wylot	12	26	34	36	35	31	33	18	41
	Emitowany	6	4	1	12	15	14	15	3	21

Częst. Hz/dB(A)		63	125	250	500	1000	2000	4000	8000	L _{WA}
1	Wlot	35	38	49	57	56	55	55	43	62
	Wylot	30	38	50	56	54	54	52	41	61
	Emitowany	23	20	26	33	36	3	37	26	42
2	Wlot	32	36	47	54	54	53	52	40	60
	Wylot	31	40	49	55	54	53	52	40	60
	Emitowany	22	18	25	31	35	35	35	24	40
3	Wlot	36	43	55	58	58	56	53	41	63
	Wylot	33	47	54	57	57	55	53	40	63
	Emitowany	24	24	31	33	37	36	35	24	42
4	Wlot	31	34	46	54	53	52	51	39	59
	Wylot	26	35	46	52	51	50	48	37	57
	Emitowany	20	16	22	29	33	33	33	22	39
5	Wlot	29	32	44	51	50	49	48	37	56
	Wylot	27	36	45	51	50	49	48	36	56
	Emitowany	18	15	21	27	31	31	31	21	37
6	Wlot	32	40	51	55	54	52	50	38	60
	Wylot	30	43	51	54	53	51	49	36	59
	Emitowany	20	21	27	30	33	33	31	20	39
7	Wlot	25	29	40	48	47	46	45	34	53
	Wylot	20	29	41	47	45	45	43	31	52
	Emitowany	14	10	17	23	2	27	28	17	33
8	Wlot	23	27	38	45	44	44	42	31	50
	Wylot	22	31	39	46	44	43	43	30	51
	Emitowany	13	9	15	21	25	26	26	15	31
9	Wlot	27	34	46	49	48	46	44	32	54
	Wylot	24	37	45	48	47	45	43	30	53
	Emitowany	15	15	22	24	28	27	26	15	33
10	Wlot	18	21	33	41	39	39	38	26	46
	Wylot	13	22	33	39	38	37	35	24	44
	Emitowany	7	3	9	16	20	20	20	9	25
11	Wlot	16	19	31	38	37	36	35	24	43
	Wylot	14	23	32	38	37	36	35	23	43
	Emitowany	5	2	8	14	18	18	18	8	24
12	Wlot	19	27	38	42	41	39	37	25	47
	Wylot	17	30	38	41	40	38	36	23	46
	Emitowany	7	8	14	17	20	20	18	7	26

CHARAKTERYSTYKI PRACY

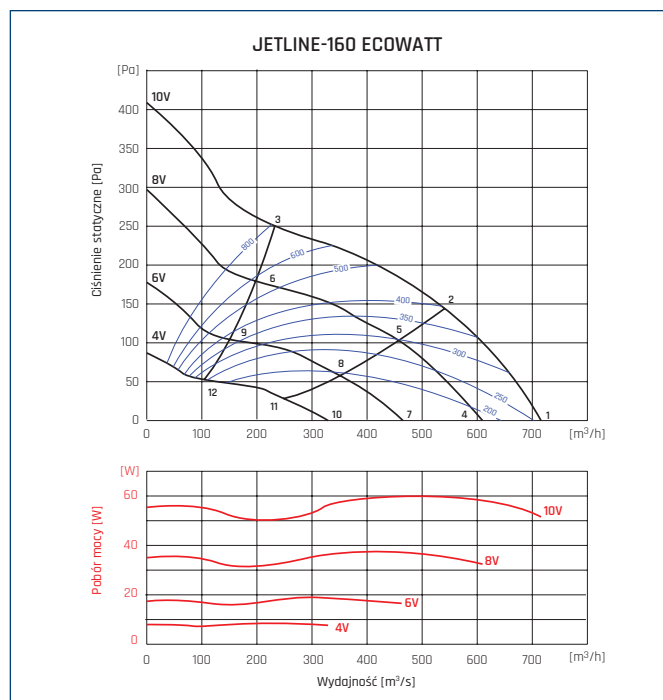
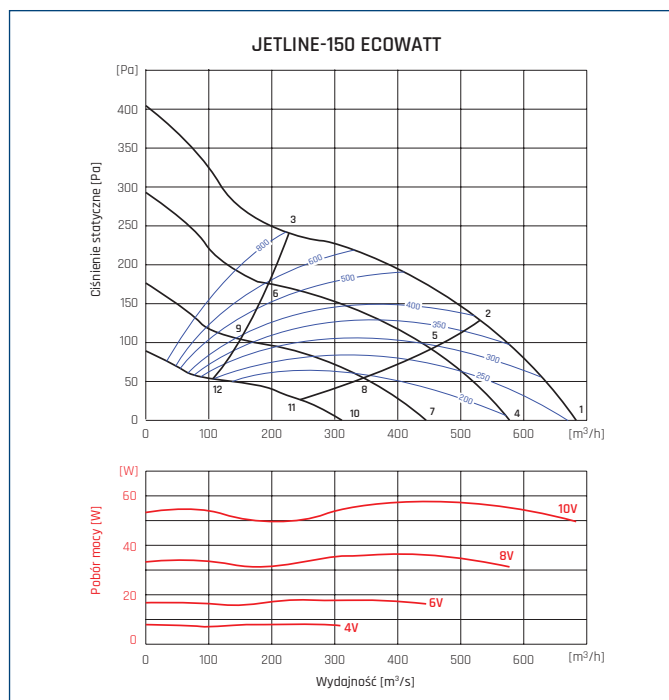

Częst. Hz/dB(A)		63	125	250	500	1000	2000	4000	8000	L _{WA}
1	Wlot	35	43	55	61	61	61	60	53	67
	Wylot	34	43	57	62	61	61	59	51	68
	Emitowany	23	25	33	38	43	44	43	35	49
2	Wlot	34	40	53	60	60	59	57	49	66
	Wylot	34	43	54	60	60	60	56	47	66
	Emitowany	22	23	31	37	42	42	41	32	47
3	Wlot	40	48	59	63	63	62	58	48	69
	Wylot	39	50	58	61	62	62	56	45	68
	Emitowany	27	30	37	39	44	45	40	30	49
4	Wlot	32	39	52	58	58	57	56	49	64
	Wylot	30	39	54	59	58	58	55	47	64
	Emitowany	19	22	30	35	40	41	40	32	46
5	Wlot	31	36	50	57	57	56	53	46	62
	Wylot	31	40	51	57	57	56	52	44	62
	Emitowany	18	19	28	34	39	39	37	28	44
6	Wlot	36	44	56	59	59	59	54	45	65
	Wylot	35	47	55	58	59	58	53	42	64
	Emitowany	23	26	33	36	41	41	37	27	46
7	Wlot	26	33	46	52	52	52	51	44	58
	Wylot	24	34	48	53	52	52	50	41	59
	Emitowany	14	16	24	29	34	35	34	26	40
8	Wlot	25	31	44	51	51	50	48	40	56
	Wylot	25	34	45	51	51	50	47	38	56
	Emitowany	13	14	22	28	33	33	31	23	38
9	Wlot	30	39	50	54	54	53	49	39	59
	Wylot	30	41	49	52	53	53	47	36	58
	Emitowany	17	21	27	30	35	35	31	21	40
10	Wlot	19	26	39	45	45	44	43	36	51
	Wylot	17	26	41	46	45	45	42	34	51
	Emitowany	6	9	17	22	27	28	27	19	33
11	Wlot	18	23	37	44	44	43	40	33	49
	Wylot	18	27	38	44	44	43	39	31	49
	Emitowany	5	6	15	21	26	26	24	15	31
12	Wlot	23	31	43	46	46	46	41	32	52
	Wylot	22	34	42	45	46	45	40	29	51
	Emitowany	10	13	20	23	28	28	24	14	33

Częst. Hz/dB(A)		63	125	250	500	1000	2000	4000	8000	L _{WA}
1	Wlot	35	43	55	61	61	61	60	53	67
	Wylot	34	43	57	62	61	61	59	51	68
	Emitowany	23	25	33	38	43	44	43	35	49
2	Wlot	34	40	53	60	60	59	57	49	66
	Wylot	34	43	54	60	60	60	56	47	66
	Emitowany	22	23	31	37	42	42	41	32	47
3	Wlot	40	48	59	63	63	62	58	48	69
	Wylot	39	50	58	61	62	62	56	45	68
	Emitowany	27	30	37	39	44	45	40	30	49
4	Wlot	32	39	52	58	58	57	56	49	64
	Wylot	30	39	54	59	58	58	55	47	64
	Emitowany	19	22	30	35	40	40	40	32	46
5	Wlot	31	36	50	56	57	56	53	46	62
	Wylot	31	40	51	56	56	56	52	44	62
	Emitowany	18	19	28	34	39	39	37	28	44
6	Wlot	36	44	56	59	59	59	54	45	65
	Wylot	35	47	55	58	58	58	52	42	64
	Emitowany	23	26	33	36	41	41	37	26	46
7	Wlot	26	33	46	52	52	52	51	44	58
	Wylot	24	34	48	53	52	52	50	41	59
	Emitowany	14	16	24	29	34	35	34	26	40
8	Wlot	25	31	44	51	51	50	48	40	56
	Wylot	25	34	45	51	51	50	47	38	56
	Emitowany	13	14	22	28	33	33	31	23	38
9	Wlot	30	36	50	54	54	53	49	39	59
	Wylot	30	41	49	52	53	53	47	36	58
	Emitowany	17	21	27	30	35	35	31	21	40
10	Wlot	18	26	39	45	45	44	43	36	51
	Wylot	17	26	41	46	45	45	42	34	51
	Emitowany	6	9	17	22	27	27	27	19	33
11	Wlot	18	23	37	43	44	43	40	33	49
	Wylot	18	27	38	43	43	43	39	31	49
	Emitowany	5	6	15	21	26	26	24	15	31
12	Wlot	23	31	43	46	46	46	41	32	52
	Wylot	22	34	42	45	46	45	40	29	51
	Emitowany	10	13	20	23	28	28	24	13	33

CHARAKTERYSTYKI PRACY

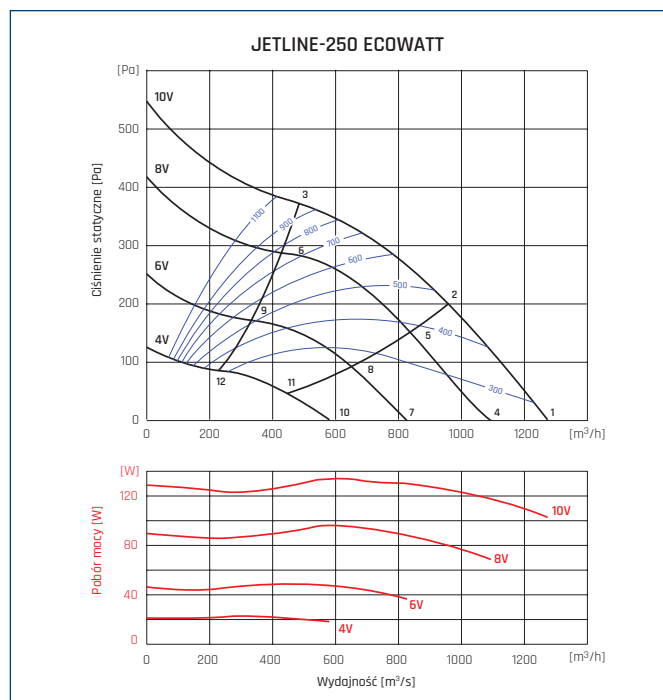
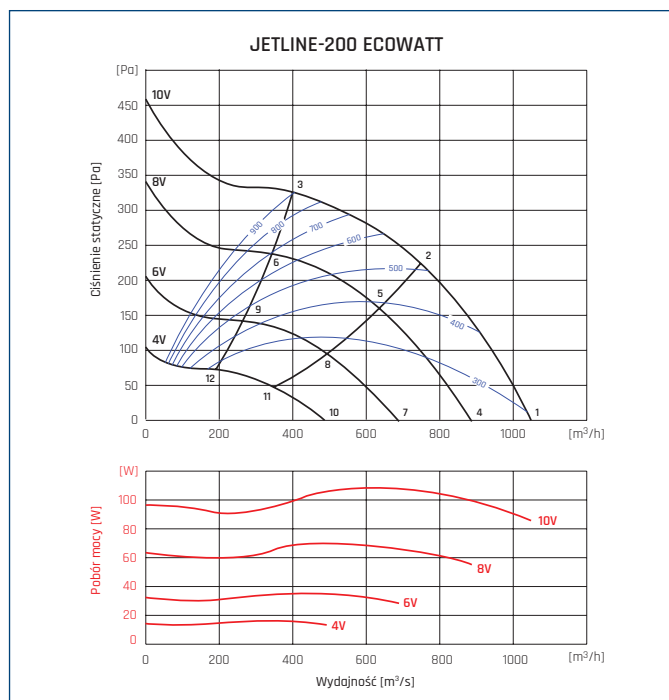

Częst. Hz/dB(A)		63	125	250	500	1000	2000	4000	8000	L _{WA}
1	Wlot	36	46	60	65	65	65	64	60	72
	Wylot	36	45	62	66	65	66	63	57	72
	Emitowany	22	29	38	42	47	48	47	41	53
2	Wlot	35	42	57	64	65	63	60	55	70
	Wylot	37	46	58	63	64	64	58	52	70
	Emitowany	22	26	36	42	48	47	45	37	52
3	Wlot	42	50	62	66	66	66	61	52	72
	Wylot	42	53	61	64	65	66	58	48	71
	Emitowany	28	33	40	43	48	49	43	33	53
4	Wlot	33	43	57	61	62	62	61	5	68
	Wylot	32	42	58	62	62	62	59	53	68
	Emitowany	19	25	35	36	44	45	44	38	50
5	Wlot	32	39	54	61	61	60	57	52	66
	Wylot	33	42	55	60	61	61	55	49	66
	Emitowany	19	23	33	39	44	44	41	34	49
6	Wlot	38	47	58	62	63	63	57	49	68
	Wylot	39	49	57	61	62	63	55	45	67
	Emitowany	24	29	36	39	45	46	40	30	50
7	Wlot	27	37	51	56	56	56	55	51	63
	Wylot	27	36	53	57	57	57	54	48	63
	Emitowany	13	20	29	33	38	40	36	32	44
8	Wlot	26	34	48	55	56	54	51	46	61
	Wylot	28	37	49	55	56	55	50	44	61
	Emitowany	13	17	27	33	39	39	36	28	43
9	Wlot	33	41	53	57	57	57	52	44	63
	Wylot	33	44	52	55	56	57	49	39	62
	Emitowany	19	24	31	34	39	41	35	25	44
10	Wlot	20	30	44	49	49	49	48	44	55
	Wylot	19	29	46	49	49	50	47	40	56
	Emitowany	6	13	22	25	31	32	31	25	37
11	Wlot	19	26	41	46	48	47	44	39	54
	Wylot	21	29	42	47	48	48	42	36	53
	Emitowany	6	10	20	26	32	31	29	21	36
12	Wlot	25	34	46	49	50	50	44	36	56
	Wylot	26	36	44	48	49	50	42	32	55
	Emitowany	11	17	24	27	32	33	27	1	37

Częst. Hz/dB(A)		63	125	250	500	1000	2000	4000	8000	L _{WA}
1	Wlot	36	48	62	66	67	67	66	64	74
	Wylot	36	46	64	67	67	68	65	60	74
	Emitowany	22	31	41	44	50	52	50	45	56
2	Wlot	36	45	60	67	68	66	63	59	73
	Wylot	38	47	60	65	67	67	60	55	72
	Emitowany	22	28	39	45	51	50	47	40	55
3	Wlot	43	52	63	67	68	69	62	55	74
	Wylot	45	55	63	67	68	70	60	51	74
	Emitowany	29	35	42	45	51	53	46	36	56
4	Wlot	33	45	59	63	64	64	63	61	70
	Wylot	33	43	61	64	64	65	62	57	70
	Emitowany	19	28	38	41	47	48	46	42	53
5	Wlot	33	41	57	63	64	63	60	56	69
	Wylot	34	43	57	62	63	63	56	52	68
	Emitowany	19	25	35	41	48	47	44	37	52
6	Wlot	40	49	60	64	65	66	59	52	71
	Wylot	42	52	60	63	65	67	57	48	71
	Emitowany	25	32	39	42	48	50	42	33	53
7	Wlot	27	39	54	58	58	59	58	55	65
	Wylot	28	37	55	59	59	59	56	51	65
	Emitowany	13	23	32	35	42	43	41	36	47
8	Wlot	28	36	51	58	59	57	54	51	64
	Wylot	29	38	52	56	58	58	51	46	63
	Emitowany	13	19	30	36	42	42	38	32	47
9	Wlot	34	43	55	59	59	60	54	46	65
	Wylot	37	46	54	58	59	61	51	43	65
	Emitowany	20	26	33	37	43	44	37	27	48
10	Wlot	20	32	46	50	51	51	50	48	57
	Wylot	20	30	48	51	51	52	48	44	57
	Emitowany	6	15	25	28	34	35	33	29	40
11	Wlot	20	28	44	50	51	50	46	43	56
	Wylot	21	30	44	49	50	50	43	39	55
	Emitowany	6	11	22	28	35	34	31	24	39
12	Wlot	27	36	47	51	52	52	46	39	58
	Wylot	29	39	47	50	52	54	44	35	58
	Emitowany	12	19	26	29	35	37	29	20	40

CHARAKTERYSTYKI PRACY

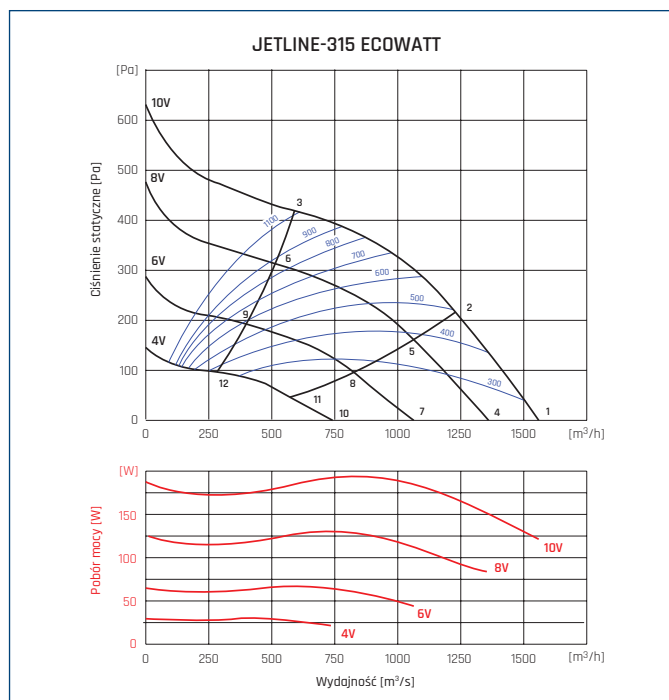

Częst. Hz/dB(A)		63	125	250	500	1000	2000	4000	8000	L _{WA}
1	Wlot	36	50	65	68	69	70	69	69	76
	Wylot	38	46	67	70	71	71	68	64	77
	Emitowany	22	35	45	47	54	56	53	50	60
2	Wlot	37	47	63	70	71	69	65	64	76
	Wylot	40	48	63	68	70	70	62	59	75
	Emitowany	23	31	43	48	55	55	50	45	59
3	Wlot	44	54	65	69	70	72	64	58	76
	Wylot	47	56	65	68	70	73	61	54	76
	Emitowany	30	37	44	48	54	57	48	38	60
4	Wlot	33	47	62	65	66	66	65	65	73
	Wylot	35	45	64	67	67	68	65	61	74
	Emitowany	19	32	42	44	51	53	50	4	57
5	Wlot	34	43	60	66	68	66	62	61	73
	Wylot	36	45	60	65	67	67	58	56	72
	Emitowany	20	27	39	45	52	51	47	41	56
6	Wlot	41	50	62	66	67	68	61	55	73
	Wylot	44	53	61	65	67	70	58	50	73
	Emitowany	26	34	41	45	51	53	45	35	56
7	Wlot	27	41	56	59	61	61	60	60	68
	Wylot	29	39	59	61	62	63	59	56	68
	Emitowany	14	26	37	39	46	47	45	41	52
8	Wlot	29	38	54	61	62	61	5	55	67
	Wylot	31	40	55	59	61	62	53	50	66
	Emitowany	14	22	34	40	47	46	42	36	51
9	Wlot	36	45	56	61	62	63	56	49	67
	Wylot	39	46	56	60	62	64	53	45	68
	Emitowany	21	29	36	39	46	48	39	30	51
10	Wlot	20	34	49	52	53	54	53	53	60
	Wylot	22	32	51	54	55	55	52	48	61
	Emitowany	6	19	30	32	38	40	37	34	44
11	Wlot	21	31	47	54	55	53	49	48	60
	Wylot	24	32	47	52	54	54	46	43	59
	Emitowany	7	15	27	33	40	39	35	29	43
12	Wlot	28	38	49	53	54	56	48	42	60
	Wylot	32	41	49	52	54	57	45	38	60
	Emitowany	14	22	29	32	39	41	32	23	44

WYMIARY [mm]

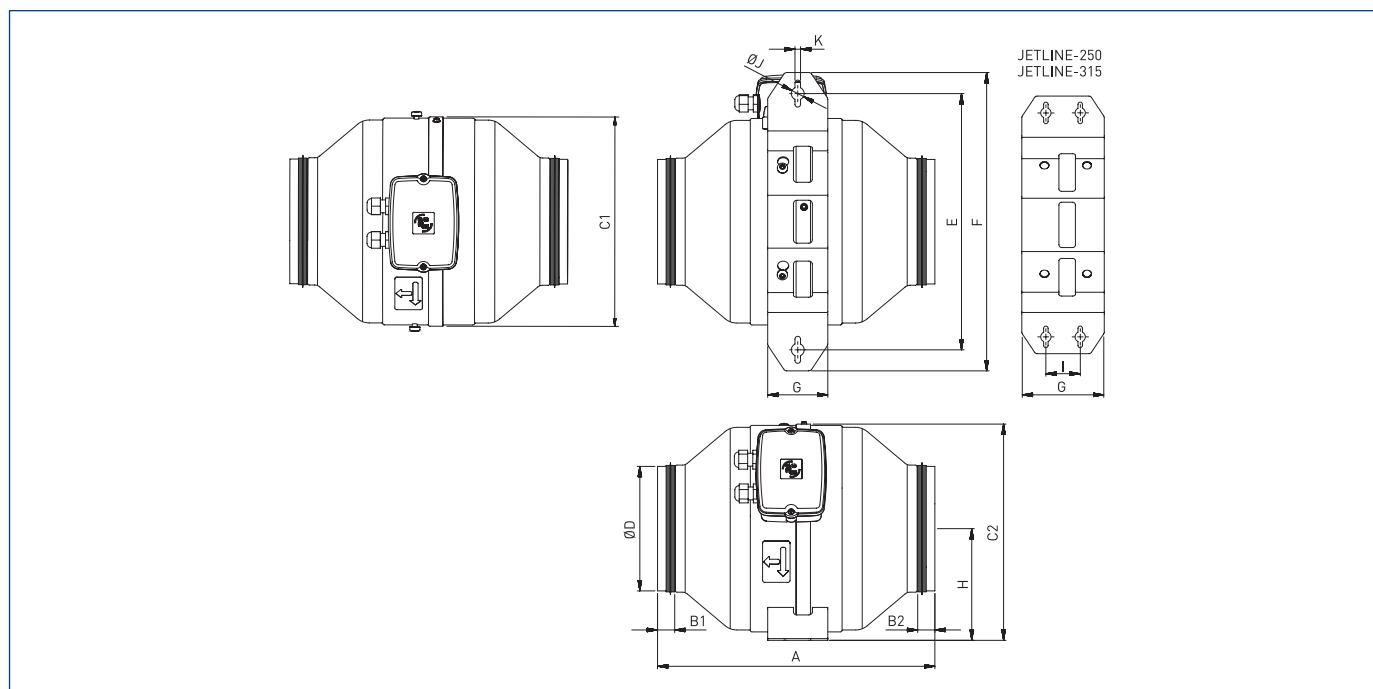

Typ	A	B1	B2	C1	C2	ØD	E	F	G	H	I	ØJ	K
JETLINE-100 ECOWATT	276	15	15	181	190	95	256	306	70	98	-	15	6,5
JETLINE-125 ECOWATT	279	15	15	206	214	120	265	315	70	111	-	15	6,5
JETLINE-150 ECOWATT	323	20	20	243,5	252	145	298,5	348	70	130	-	15	6,5
JETLINE-160 ECOWATT	323	20	20	243,5	252	155	298,5	348	70	130	-	15	6,5
JETLINE-200 ECOWATT	322	30	30	273	281	195	320	369	100	144,5	-	15	6,5
JETLINE-250 ECOWATT	329	20	30	293	301	245	326	375	120	154,3	50	15	6,5
JETLINE-315 ECOWATT	369	20	33	322	331	310	357,5	407	120	170	50	15	6,5

AKCESORIA MONTAŻOWE

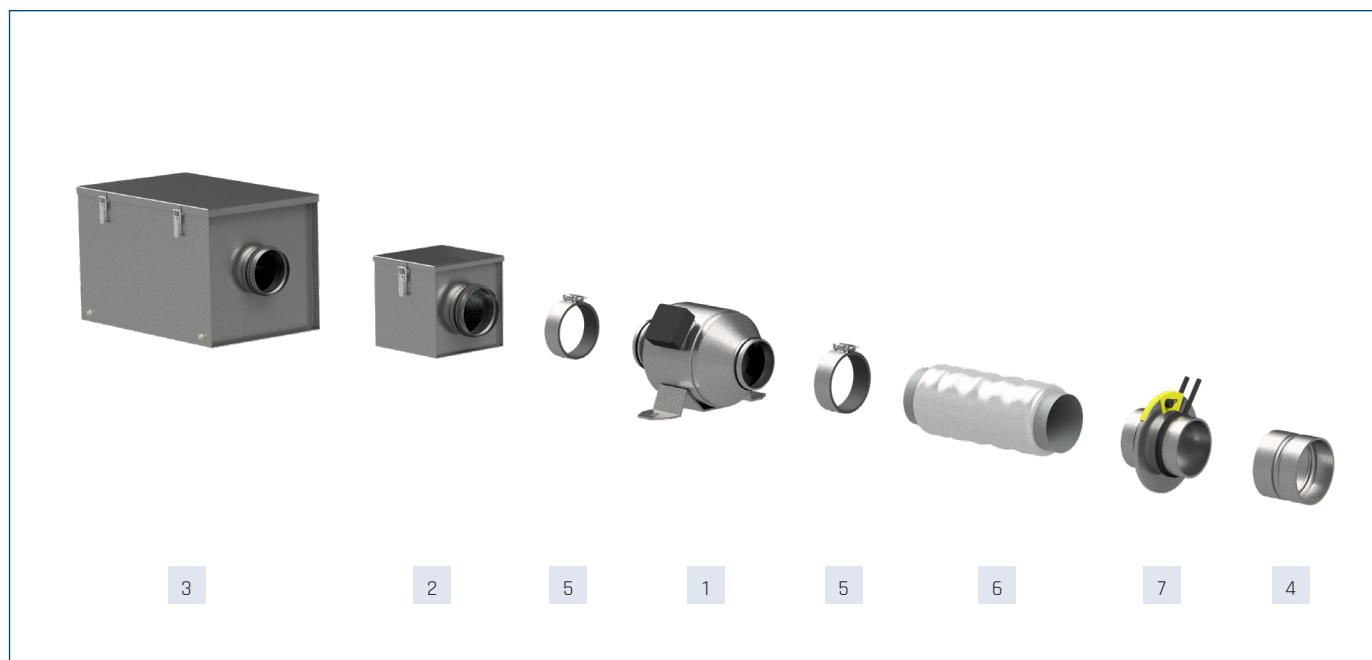

1 Wentylator	2 filtr kanałowy DF	3 filtr kanałowy DF-K				
		wkład filtracyjny do DF-K				
		EU3	EU5	EU7	EU9	
JETLINE-100 ECOWATT	DF 100	DF-K 100	EU3 100-250mm	EU5 100-250mm	EU7 100-250mm	EU9 100-250mm
JETLINE-125 ECOWATT	DF 125	DF-K 125	EU3 100-250mm	EU5 100-250mm	EU7 100-250mm	EU9 100-250mm
JETLINE-150 ECOWATT	DF 160*	DF-K 160*	EU3 100-250mm*	EU5 100-250mm*	EU7 100-250mm*	EU9 100-250mm*
JETLINE-160 ECOWATT	DF 160	DF-K 160	EU3 100-250mm	EU5 100-250mm	EU7 100-250mm	EU9 100-250mm
JETLINE-200 ECOWATT	DF 200	DF-K 200	EU3 100-250mm	EU5 100-250mm	EU7 100-250mm	EU9 100-250mm
JETLINE-250 ECOWATT	DF 250	DF-K 250	EU3 100-250mm	EU5 100-250mm	EU7 100-250mm	EU9 100-250mm
JETLINE-315 ECOWATT	DF 315	DF-K 315	EU3 315-450mm	EU5 315-450mm	EU7 315-450mm	-

1 Wentylator	4 klapa zwrotna CAR-PL	5 złącze przeciwdrganiowe ACOP PL	6 tłumik akustyczny AKU-COMP		7 przepustnica soczewk. IRIS	8 kratka wentylacyjna KWO	9 siatka ochronna DEF-VENT
			0,6m	1,2m			
JETLINE-100 ECOWATT	CAR-PL 100	ACOP PL 100	AKU-COMP 100/0,6	AKU-COMP 100/1,2	IRIS 100	KWO 100	DEF-VENT 100
JETLINE-125 ECOWATT	CAR-PL 125	ACOP PL 125	AKU-COMP 125/0,6	AKU-COMP 125/1,2	IRIS 125	KWO 125	DEF-VENT 125
JETLINE-150 ECOWATT	CAR-PL 150	ACOP PL 150	AKU-COMP 160/0,6*	AKU-COMP 160/1,2*	IRIS 150	KWO 160*	DEF-VENT 150
JETLINE-160 ECOWATT	CAR-PL 160	ACOP PL 160	AKU-COMP 160/0,6	AKU-COMP 160/1,2	IRIS 160	KWO 160	DEF-VENT 160
JETLINE-200 ECOWATT	CAR-PL 200	ACOP PL 200	AKU-COMP 200/0,6	AKU-COMP 200/1,2	IRIS 200	KWO 200	DEF-VENT 200
JETLINE-250 ECOWATT	CAR-PL 250	ACOP PL 250	AKU-COMP 250/0,6	AKU-COMP 250/1,2	IRIS 250	KWO 250	DEF-VENT 250
JETLINE-315 ECOWATT	CAR-PL 315	ACOP PL 315	AKU-COMP 315/0,6	AKU-COMP 315/1,2	IRIS 315	KWO 315	DEF-VENT 315

* akcesoria montażowe dedykowane do średnicy 160mm

Numery artykułów

ACOP PL 100	40521810	AKU-COMP 200/0.6	40521540	DF 100	40520610	EU3 315-450mm	40520830	KWO 125	40522530
ACOP PL 125	40521815	AKU-COMP 200/1.2	40521640	DF 125	40520620	EU5 100-250mm	40520805	KWO 160	40522540
ACOP PL 150	40521818	AKU-COMP 250/0.6	40521550	DF 160	40520630	EU5 315-450mm	40520835	KWO 200	40522550
ACOP PL 160	40521820	AKU-COMP 250/1.2	40521650	DF 200	40520640	EU7 100-250mm	40520810	KWO 250	40522560
ACOP PL 200	40521825	AKU-COMP 315/0.6	40521560	DF 250	40520650	EU7 315-450mm	40520840	KWO 315	40522570
ACOP PL 250	40521830	AKU-COMP 315/1.2	40521660	DF 315	40520660	EU9 100-250mm	40520820	DEF-VENT-100	40522010
ACOP PL 315	40521835	CAR-PL 100	40521010-01	DF-K 100	40521710	IRIS 100	19527100	DEF-VENT-125	40522011
AKU-COMP 100/0.6	40521510	CAR-PL 125	40521020-01	DF-K 125	40521715	IRIS 125	19527125	DEF-VENT-160	40522012
AKU-COMP 100/1.2	40521610	CAR-PL 150	40521029-01	DF-K 160	40521720	IRIS 160	19527160	DEF-VENT-200	40522013
AKU-COMP 125/0.6	40521520	CAR-PL 160	40521030-01	DF-K 200	40521725	IRIS 200	19527200	DEF-VENT-250	40522014
AKU-COMP 125/1.2	40521620	CAR-PL 200	40521040-01	DF-K 250	40521730	IRIS 250	19527250	DEF-VENT-315	40522015
AKU-COMP 160/0.6	40521530	CAR-PL 250	40521050-01	DF-K 315	40521735	IRIS 315	19527315		
AKU-COMP 160/1.2	40521630	CAR-PL 315	40521060-01	EU3 100-250mm	40520800	KWO 100	40522520		



AKCESORIA ELEKTRYCZNE

Wentylator	termostat ścienny	termostat kanałowy	termostat	czujnik termostatu	czujnik zanieczyszczeń	higrostat	regulator	przełącznik
	TS	TK-1	TK-21	3 MB	SQA	HIG-2	REB-ECOWATT	EC CONTROL
JETLINE-100 ECOWATT	TS	TK-1	TK-21	3 MB	SQA	HIG-2	REB-ECOWATT	EC CONTROL 3V
JETLINE-125 ECOWATT	TS	TK-1	TK-21	3 MB	SQA	HIG-2	REB-ECOWATT	EC CONTROL 3V
JETLINE-150 ECOWATT	TS	TK-1	TK-21	3 MB	SQA	HIG-2	REB-ECOWATT	EC CONTROL 3V
JETLINE-160 ECOWATT	TS	TK-1	TK-21	3 MB	SQA	HIG-2	REB-ECOWATT	EC CONTROL 3V
JETLINE-200 ECOWATT	TS	TK-1	TK-21	3 MB	SQA	HIG-2	REB-ECOWATT	EC CONTROL 3V
JETLINE-250 ECOWATT	TS	TK-1	TK-21	3 MB	SQA	HIG-2	REB-ECOWATT	EC CONTROL 3V
JETLINE-315 ECOWATT	TS	TK-1	TK-21	3 MB	SQA	HIG-2	REB-ECOWATT	EC CONTROL 3V

Numery artykułów

HIG-2	40025150	REB-ECOWATT	40025005	SQA	40025140	TK-1	40025330	TS	40025345
EC CONTROL 3V	40015510	TK-21	40025320						



CHARAKTERYSTYKA ERP

SWM*		
	Nazwa produktu	JETLINE-100 ECOWATT
a	Nazwa dostawcy	VENTURE INDUSTRIES / SOLER&PALAU
b	Numer artykułu	40021950
c	JZE umiarkowany (SEC Avarage) [kWh/m2rok]	-13,87
c	JZE chłodny (SEC cold)	-30
c	JZE ciepły (SEC warm)	-4
c	JZE (SEC) klasa	
d	Kategoria urządzenia	SWM (RVU)
d	Typ urządzenia	JSW (UVU)
e	Napęd	bezstopniowy
f	Typ odzysku ciepła	brak
g	Sprawność temperaturowa [%]	nie dotyczy
h	Maksymalny przepływ powietrza [m3/h]	184
i	Maksymalny pobór mocy [W]	19,11
j	Moc akustyczna [dB(A)]	28
k	Wartość odniesienia natężenia przepływu [m3/s]	0,0362
l	Wartość odniesienia różnicy ciśnienia [Pa]	45,65
m	JPM/SPI [W/m3/h]	0,1049
n	CRS/CTRL	1
o	Stopień zewnętrznych przecieków powietrza [%]	0,5
p	Stopień mieszania	nie dotyczy
q	Ostrzeżenia o konieczności wymiany filtra	nie dotyczy
r	Instrukcja instalowania kratki wentylacyjnych	nie dotyczy
s	Strona internetowa	venture.pl / solerpalau.com
t	Podatność przepływu na zmiany ciśnienia	nie dotyczy
u	Szczelność	nie dotyczy
v	Roczne zużycie energii elektrycznej-umiarkowany [kWh/m2rok]	1,31
v	Roczne zużycie energii elektrycznej-chłodny [kWh/m2rok]	1,31
v	Roczne zużycie energii elektrycznej-ciepły [kWh/m2rok]	1,31
w	R00 klimat chłodny	33,55
w	R00 klimat umiarkowany	17,15
w	R00 klimat ciepły	7,76

* SWM-"system wentylacyjny przeznaczony do budynków mieszkalnych"-zgodnie z Rozporządzeniem Komisji (UE) nr 1254/2014

CHARAKTERYSTYKA ERP

SWNM*				
	Nazwa produktu	JETLINE-125 ECOWATT	JETLINE-150 ECOWATT	JETLINE-160 ECOWATT
a	Nazwa dostawcy	VENTURE INDUSTRIES / SOLER&PALAU	VENTURE INDUSTRIES / SOLER&PALAU	VENTURE INDUSTRIES / SOLER&PALAU
b	Numer artykułu	40021958	40021959	40021960
c	Kategoria urządzenia	SWNM (NRVU)	SWNM (NRVU)	SWNM (NRVU)
c	Typ urządzenia	JSW (UVU)	JSW (UVU)	JSW (UVU)
d	Napęd	bezstopniowy	bezstopniowy	bezstopniowy
e	Typ odzysku ciepła	brak	brak	brak
f	Sprawność temperaturowa [%]	nie dotyczy	nie dotyczy	nie dotyczy
g	Znamionowe natężenie przepływu w SWNM [m3/s]			
h	Efektywny pobór mocy [kW]			
i	JMWint [W/(m3/s)]	nie dotyczy	nie dotyczy	nie dotyczy
j	Prędkość czotowa [m/s]			
k	$\Delta ps, ext$ [Pa]			
l	$\Delta ps, int$ [Pa]	nie dotyczy	nie dotyczy	nie dotyczy
m	$\Delta ps, add$ [Pa]	nie dotyczy	nie dotyczy	nie dotyczy
n	Sprawność statyczna wentylatora [%]			
o	Stopień zewnętrznych przecieków powietrza [%]			
p	Stopień wewnętrznych przecieków powietrza [%]	nie dotyczy	nie dotyczy	nie dotyczy
q	Efektywność energetyczna filtra	nie dotyczy	nie dotyczy	nie dotyczy
r	Ostrzeżenia o konieczności wymiany filtra	nie dotyczy	nie dotyczy	nie dotyczy
s	LWA [dB(A)]			
s	Strona internetowa	venture.pl solerpalau.com	venture.pl solerpalau.com	venture.pl solerpalau.com

SWNM*				
	Nazwa produktu	JETLINE-200 ECOWATT	JETLINE-250 ECOWATT	JETLINE-315 ECOWATT
a	Nazwa dostawcy	VENTURE INDUSTRIES / SOLER&PALAU	VENTURE INDUSTRIES / SOLER&PALAU	VENTURE INDUSTRIES / SOLER&PALAU
b	Numer artykułu	40021961	40021962	40021963
c	Kategoria urządzenia	SWNM (NRVU)	SWNM (NRVU)	SWNM (NRVU)
c	Typ urządzenia	JSW (UVU)	JSW (UVU)	JSW (UVU)
d	Napęd	bezstopniowy	bezstopniowy	bezstopniowy
e	Typ odzysku ciepła	brak	brak	brak
f	Sprawność temperaturowa [%]	nie dotyczy	nie dotyczy	nie dotyczy
g	Znamionowe natężenie przepływu w SWNM [m3/s]			
h	Efektywny pobór mocy [kW]			
i	JMWint [W/(m3/s)]	nie dotyczy	nie dotyczy	nie dotyczy
j	Prędkość czotowa [m/s]			
k	$\Delta ps, ext$ [Pa]			
l	$\Delta ps, int$ [Pa]	nie dotyczy	nie dotyczy	nie dotyczy
m	$\Delta ps, add$ [Pa]	nie dotyczy	nie dotyczy	nie dotyczy
n	Sprawność statyczna wentylatora [%]			
o	Stopień zewnętrznych przecieków powietrza [%]			
p	Stopień wewnętrznych przecieków powietrza [%]	nie dotyczy	nie dotyczy	nie dotyczy
q	Efektywność energetyczna filtra	nie dotyczy	nie dotyczy	nie dotyczy
r	Ostrzeżenia o konieczności wymiany filtra	nie dotyczy	nie dotyczy	nie dotyczy
s	LWA [dB(A)]			
s	Strona internetowa	venture.pl solerpalau.com	venture.pl solerpalau.com	venture.pl solerpalau.com

* SWNM - "system wentylacyjny przeznaczony do budynków niemieszkalnych" - zgodnie z Rozporządzeniem Komisji (UE) nr 1253/2014.