



## ZASTOSOWANIE

Wentylator przeznaczony do wszelkiego rodzaju instalacji wentylacji ogólnej. Typowe zastosowania to:

- wentylacja wywiewna i nawiewna mieszkań, biur, sklepów, lokali gastronomicznych.

## KONSTRUKCJA

- obudowa z ocynkowanej blachy stalowej,
- skrzynka przyłączeniowa na obudowie,
- wspornik montażowy w standardzie,
- wirnik, łopatki kierujące i dyfuzor wylotu, wykonane z formowanego wtryskowo tworzywa sztucznego,
- uszczelka na wlocie i wylocie,
- Silent-block pomiędzy silnikiem a wspornikiem.

## SILNIK ELEKTRYCZNY

- silnik jednofazowy 220-240V 50/60Hz oraz 220-240V 50Hz (JETLINE-315),
- stopień ochrony IP 44,
- kasa izolacji F,
- zabezpieczenie termiczne z ręcznym resetem.



## DANE TECHNICZNE

Typ	wydajność max	prędkość obrotowa	napięcie	natężenie	pobór mocy max.	poziom ciśnienia akustycznego*			temperatura pracy		masa	nr. artykułu
	[m³/h]	[obr/min]	[V]	[A]	[W]	włot	wylot	emit.	min	max	[kg]	
						[dB(A)]			[°C]			
JETLINE-100	260	2690	230	0,1	19	41	39	22	-20	+60	3	40021950
JETLINE-125	420	2640	230	0,2	40	47	47	25	-20	+60	3,4	40021951
JETLINE-150	750	2730	230	0,4	83	52	50	31	-20	+60	4,5	40021952
JETLINE-160	760	2730	230	0,4	84	52	51	31	-20	+60	4,5	40021953
JETLINE-200	1080	2630	230	0,5	125	58	55	42	-20	+60	5,6	40021954
JETLINE-250	1280	2710	230	0,7	160	59	58	45	-20	+60	6,5	40021955
JETLINE-315	1610	2600	230	0,9	215	61	60	49	-20	+60	8,4	40021956

\* pomiar wykonany w odległości 1,5m od wylotu, dla  $q=2/3 q_{max}$

## CHARAKTERYSTYKI PRACY

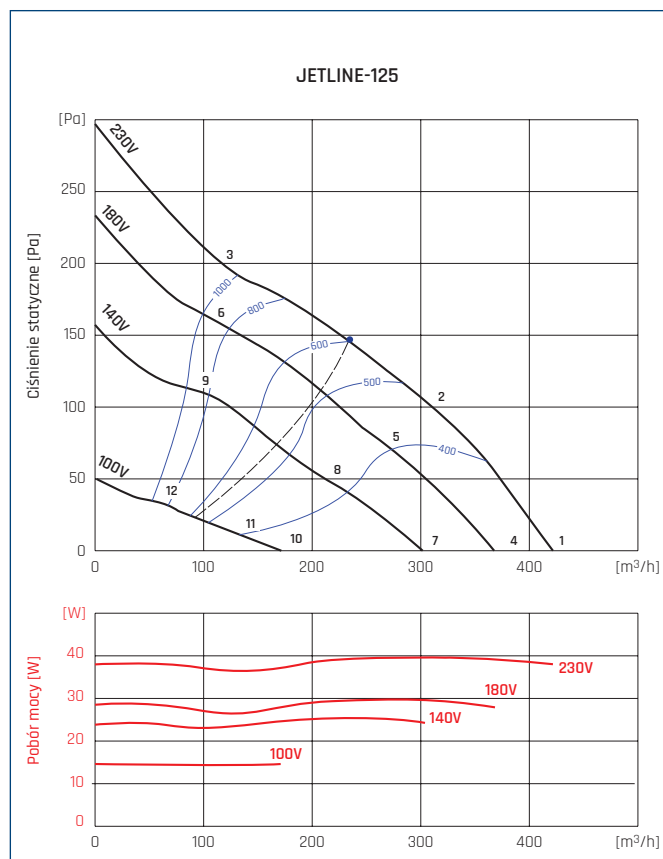
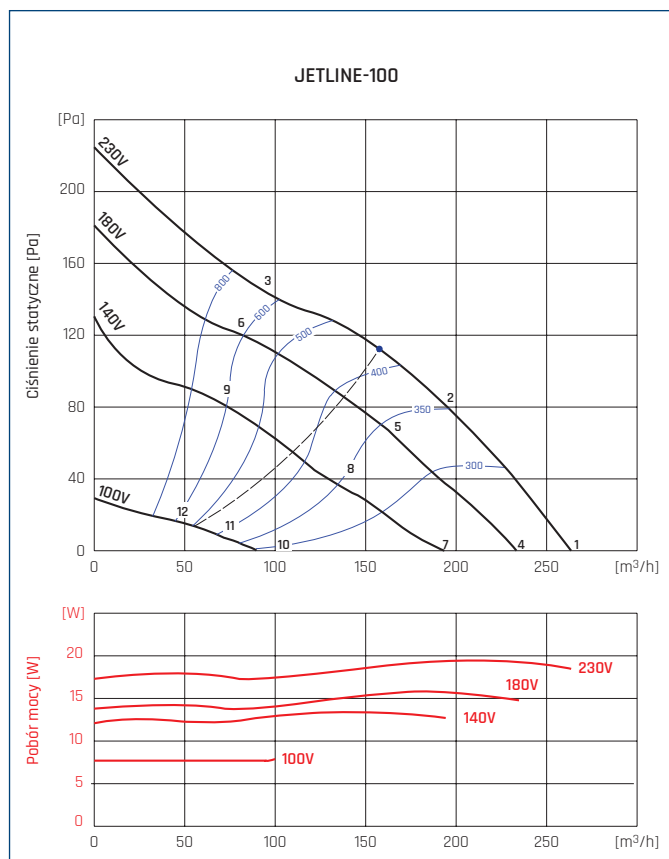

Częst. Hz/dB(A)		63	125	250	500	1000	2000	4000	8000	L <sub>WA</sub>
1	Wlot	30	33	44	50	54	51	51	36	58
	Wylot	27	32	45	49	50	49	46	34	55
	Emitowany	19	15	23	27	35	34	34	19	40
2	Wlot	27	31	42	47	51	48	48	34	55
	Wylot	27	32	44	47	48	46	46	34	53
	Emitowany	16	13	21	24	32	31	31	17	37
3	Wlot	29	39	51	52	56	51	50	36	60
	Wylot	29	41	53	51	53	39	47	35	58
	Emitowany	18	21	30	29	37	34	33	19	41
4	Wlot	27	30	41	47	51	48	48	33	55
	Wylot	24	29	42	46	47	46	43	31	53
	Emitowany	16	12	20	24	32	31	31	16	37
5	Wlot	24	28	39	44	48	45	45	31	52
	Wylot	24	29	41	44	45	43	43	31	50
	Emitowany	13	10	18	21	29	28	28	13	33
6	Wlot	27	37	49	50	54	49	48	34	57
	Wylot	27	39	51	49	51	47	45	33	56
	Emitowany	16	19	28	27	35	32	31	17	38
7	Wlot	23	26	37	43	47	44	44	29	51
	Wylot	20	25	38	42	43	42	39	27	48
	Emitowany	12	8	16	20	28	27	27	12	32
8	Wlot	18	22	33	38	42	39	39	25	47
	Wylot	18	23	35	38	39	37	37	25	45
	Emitowany	7	4	12	15	23	22	22	8	28
9	Wlot	23	33	45	46	50	45	44	30	53
	Wylot	23	35	47	45	47	43	41	29	52
	Emitowany	12	15	24	23	31	28	27	13	34

Częst. Hz/dB(A)		63	125	250	500	1000	2000	4000	8000	L <sub>WA</sub>
1	Wlot	41	38	52	63	55	56	52	43	65
	Wylot	29	45	52	61	56	56	54	41	64
	Emitowany	31	25	27	37	34	35	33	25	42
2	Wlot	40	37	50	58	52	54	51	41	61
	Wylot	28	47	48	58	54	54	54	39	62
	Emitowany	30	24	25	32	31	33	32	23	39
3	Wlot	43	46	59	63	57	56	53	42	66
	Wylot	31	52	53	61	58	56	57	40	65
	Emitowany	33	33	34	37	36	35	34	24	43
4	Wlot	39	36	50	61	53	54	50	41	62
	Wylot	27	43	50	59	54	54	52	39	62
	Emitowany	29	23	25	35	32	33	31	23	39
5	Wlot	37	34	47	55	49	51	48	38	58
	Wylot	25	44	45	55	51	51	51	36	59
	Emitowany	27	21	22	29	28	30	29	20	36
6	Wlot	41	44	57	61	55	54	51	40	64
	Wylot	29	50	51	59	56	54	55	38	63
	Emitowany	31	31	32	35	34	33	32	22	41
7	Wlot	34	31	45	56	48	49	45	36	58
	Wylot	22	38	45	54	49	49	47	34	57
	Emitowany	24	18	20	30	27	28	26	18	35
8	Wlot	32	29	42	50	44	46	43	33	53
	Wylot	20	39	40	50	46	46	46	31	54
	Emitowany	22	16	17	24	23	25	24	15	31
9	Wlot	37	40	53	57	51	50	47	36	60
	Wylot	25	46	47	55	52	50	51	34	59
	Emitowany	27	27	28	31	30	29	28	18	37

## CHARAKTERYSTYKI PRACY

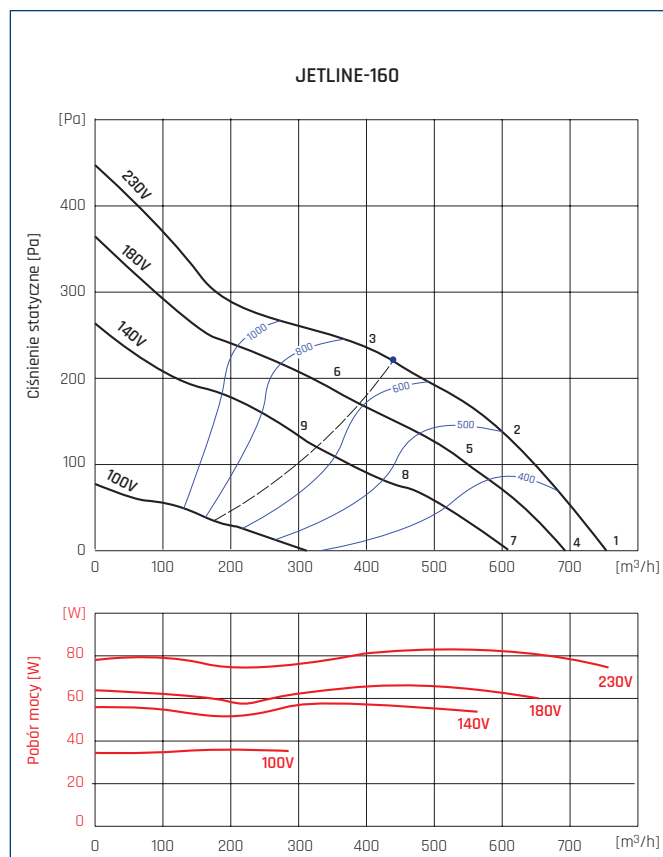
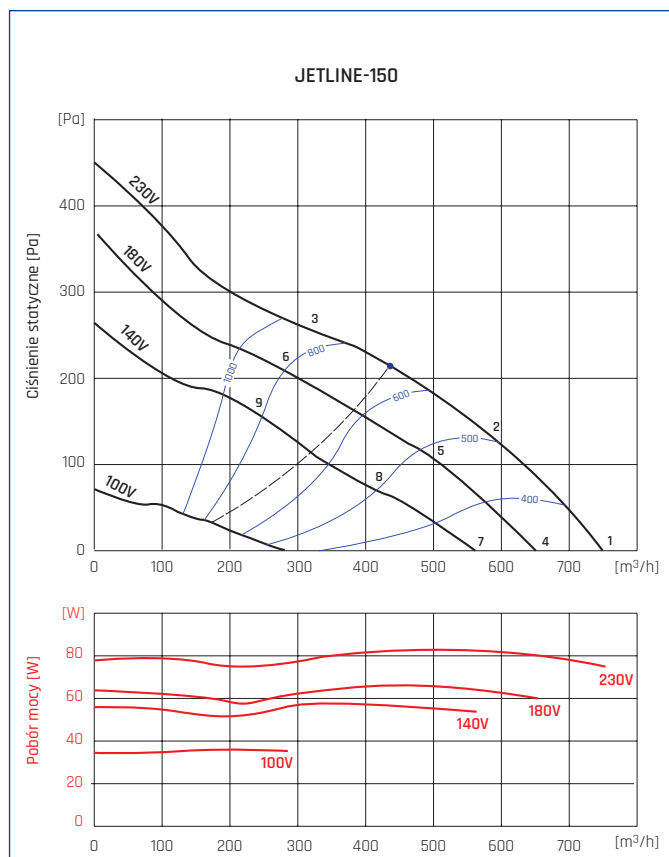

Częst. Hz/dB(A)		63	125	250	500	1000	2000	4000	8000	L <sub>WA</sub>
1	Wlot	29	40	58	62	59	61	59	50	67
	Wylot	40	43	57	62	59	59	57	46	66
	Emitowany	14	27	34	39	39	41	42	33	47
2	Wlot	28	39	58	62	58	60	57	49	66
	Wylot	28	43	56	61	57	58	55	44	65
	Emitowany	13	26	34	39	38	40	40	32	46
3	Wlot	34	43	53	61	57	60	55	47	65
	Wylot	31	46	55	61	57	58	53	42	65
	Emitowany	19	30	29	38	37	40	38	30	45
4	Wlot	27	38	56	60	57	59	57	48	65
	Wylot	38	41	55	60	57	57	55	44	65
	Emitowany	12	25	32	37	37	39	40	31	45
5	Wlot	26	37	56	60	56	58	55	47	65
	Wylot	26	41	54	59	55	56	53	42	63
	Emitowany	11	24	32	37	36	38	38	30	44
6	Wlot	32	41	51	59	55	58	53	45	64
	Wylot	29	44	53	59	55	56	51	40	63
	Emitowany	17	28	27	36	35	38	36	28	43
7	Wlot	24	35	53	57	54	56	54	45	62
	Wylot	35	38	52	57	54	54	52	41	61
	Emitowany	9	22	29	34	34	36	37	28	42
8	Wlot	22	33	52	56	52	54	51	43	61
	Wylot	22	37	50	55	51	52	49	38	59
	Emitowany	7	20	28	33	32	34	34	26	40
9	Wlot	29	38	48	56	52	55	50	42	61
	Wylot	26	41	50	56	52	53	48	37	60
	Emitowany	14	25	24	33	32	35	33	25	40

Częst. Hz/dB(A)		63	125	250	500	1000	2000	4000	8000	L <sub>WA</sub>
1	Wlot	38	49	54	63	60	62	64	52	69
	Wylot	39	42	56	63	59	59	60	51	67
	Emitowany	24	14	23	35	38	40	47	38	49
2	Wlot	36	47	54	62	58	60	60	49	67
	Wylot	44	42	55	62	58	58	57	47	66
	Emitowany	22	12	23	34	36	38	43	35	46
3	Wlot	38	45	54	61	56	60	57	47	65
	Wylot	45	46	55	61	57	58	55	45	65
	Emitowany	24	10	23	33	34	38	40	33	44
4	Wlot	36	47	52	61	58	60	62	50	67
	Wylot	37	40	54	61	57	57	58	49	65
	Emitowany	22	12	21	33	36	38	45	36	47
5	Wlot	34	45	52	60	56	58	58	47	64
	Wylot	42	40	53	60	56	56	55	45	64
	Emitowany	20	10	21	32	34	36	41	33	43
6	Wlot	36	43	52	59	54	58	55	45	63
	Wylot	43	44	53	59	55	56	53	43	63
	Emitowany	22	8	21	31	32	36	38	31	42
7	Wlot	34	45	50	59	56	58	60	48	64
	Wylot	35	38	52	59	55	55	56	47	63
	Emitowany	20	10	19	31	34	36	43	34	44
8	Wlot	30	41	48	56	52	54	54	43	61
	Wylot	38	36	49	56	52	52	51	41	60
	Emitowany	16	6	17	28	30	32	37	29	40
9	Wlot	32	39	48	55	50	54	51	41	60
	Wylot	39	40	49	55	51	52	49	39	59
	Emitowany	18	4	17	27	28	32	34	27	38

## CHARAKTERYSTYKI PRACY

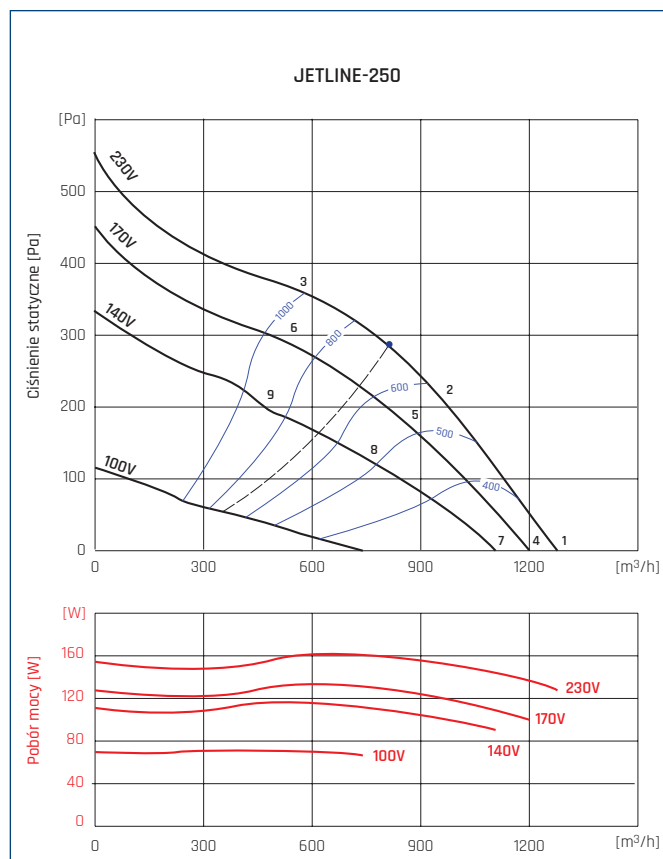
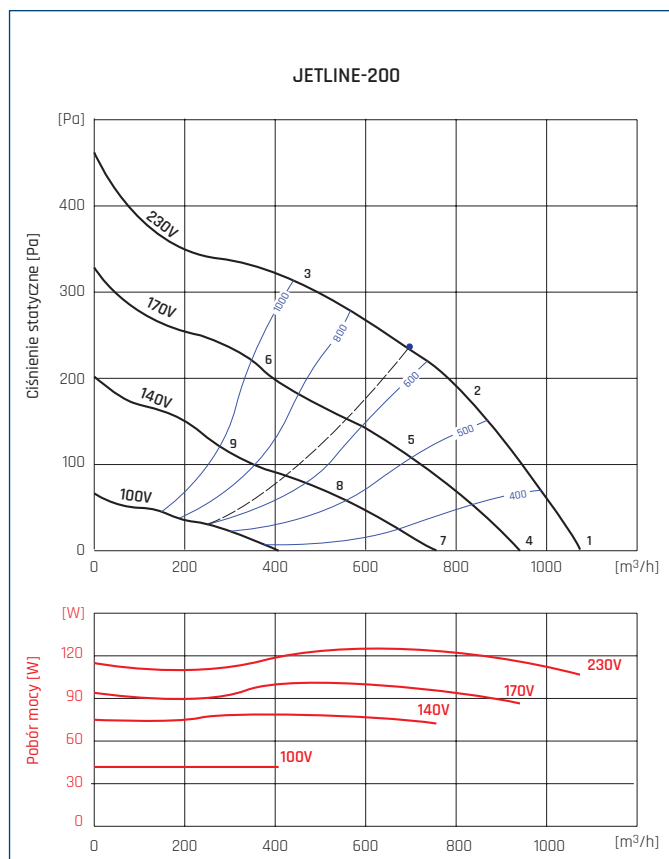

Częst. Hz/dB(A)		63	125	250	500	1000	2000	4000	8000	L <sub>WA</sub>
1	Wlot	29	44	60	65	65	64	65	60	72
	Wylot	28	45	61	65	64	63	62	56	71
	Emitowany	18	36	48	50	50	46	49	42	56
2	Wlot	30	40	56	66	68	64	62	57	72
	Wylot	28	44	57	64	65	62	58	53	69
	Emitowany	19	33	44	51	53	46	45	39	56
3	Wlot	41	51	63	68	70	68	61	54	74
	Wylot	39	55	63	66	67	67	59	51	72
	Emitowany	30	44	52	53	54	49	44	36	59
4	Wlot	26	41	57	62	63	62	62	57	69
	Wylot	25	42	58	62	62	60	59	53	68
	Emitowany	15	33	45	47	47	43	46	40	53
5	Wlot	25	36	52	62	64	60	58	52	68
	Wylot	23	40	52	60	61	58	54	48	65
	Emitowany	15	28	40	47	49	42	41	35	52
6	Wlot	37	47	60	64	66	64	57	50	70
	Wylot	35	51	59	62	63	63	55	47	68
	Emitowany	26	40	48	49	50	45	40	32	55
7	Wlot	22	36	53	58	58	57	58	53	64
	Wylot	21	37	54	58	57	56	55	48	63
	Emitowany	11	29	41	43	43	39	41	35	49
8	Wlot	20	30	46	56	58	54	52	47	62
	Wylot	17	34	47	54	55	52	48	43	59
	Emitowany	9	23	34	41	43	36	35	29	46
9	Wlot	31	42	54	58	60	58	51	44	64
	Wylot	29	45	53	57	57	57	50	41	63
	Emitowany	20	34	42	43	45	40	35	26	49

Częst. Hz/dB(A)		63	125	250	500	1000	2000	4000	8000	L <sub>WA</sub>
1	Wlot	34	47	64	65	67	68	65	66	74
	Wylot	34	46	66	65	68	70	65	60	75
	Emitowany	20	36	43	48	54	56	49	42	59
2	Wlot	41	43	60	67	70	66	61	60	73
	Wylot	34	46	62	66	68	68	58	55	73
	Emitowany	28	32	39	51	57	54	45	36	59
3	Wlot	45	52	65	66	68	67	61	54	73
	Wylot	44	54	64	65	68	70	59	52	73
	Emitowany	32	41	44	49	55	55	45	31	59
4	Wlot	32	46	63	64	66	66	63	64	72
	Wylot	33	45	64	64	67	69	64	59	73
	Emitowany	19	35	42	47	53	55	48	41	58
5	Wlot	39	41	58	65	68	64	59	58	71
	Wylot	32	44	60	64	66	66	56	53	71
	Emitowany	25	30	37	49	54	52	43	34	57
6	Wlot	43	49	62	63	66	65	59	52	71
	Wylot	41	52	62	63	66	67	57	50	71
	Emitowany	29	38	42	47	53	53	43	28	57
7	Wlot	31	44	61	62	64	65	61	62	71
	Wylot	31	43	63	62	65	67	62	57	71
	Emitowany	17	33	40	45	51	53	46	39	56
8	Wlot	36	38	55	62	65	61	56	54	68
	Wylot	29	41	57	61	63	63	53	50	68
	Emitowany	22	27	34	46	51	49	40	31	54
9	Wlot	39	46	59	60	63	62	55	49	67
	Wylot	38	48	59	59	62	64	53	47	68
	Emitowany	26	35	38	44	50	50	39	25	54

## CHARAKTERYSTYKI PRACY

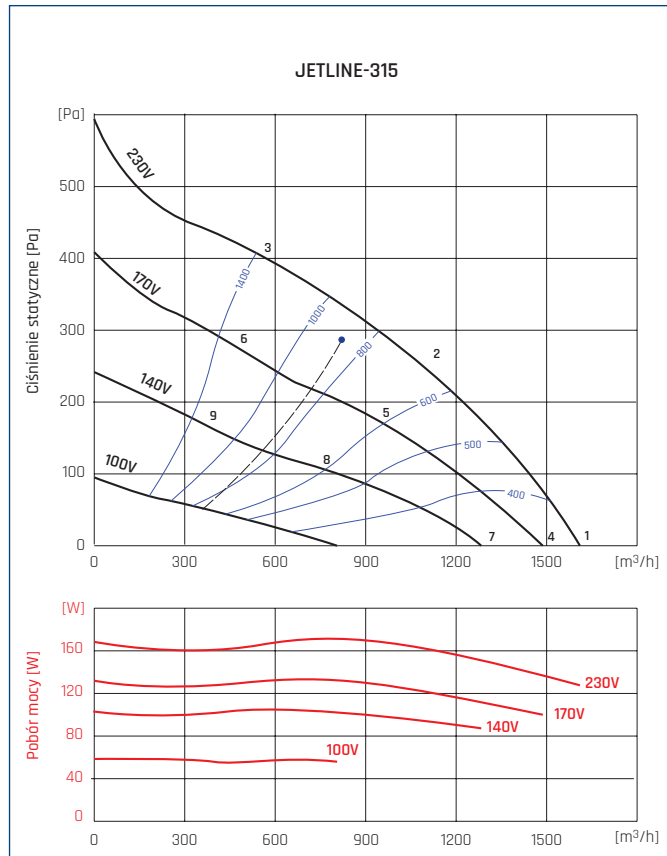

Częst. Hz/dB(A)		63	125	250	500	1000	2000	4000	8000	$L_{WA}$
1	Wlot	44	54	66	66	68	69	69	67	75
	Wylot	39	51	67	70	74	73	70	63	79
	Emitowany	29	48	60	55	61	58	53	44	66
2	Wlot	33	49	62	67	68	66	61	62	73
	Wylot	36	50	62	67	70	70	60	57	75
	Emitowany	18	43	56	56	61	55	46	39	64
3	Wlot	44	56	67	66	68	67	61	55	74
	Wylot	46	57	66	68	73	73	61	53	77
	Emitowany	29	51	62	55	61	56	45	32	65
4	Wlot	42	52	65	64	66	67	67	65	74
	Wylot	37	49	65	68	72	72	69	61	77
	Emitowany	27	47	59	53	59	56	51	42	64
5	Wlot	29	45	58	63	64	62	58	58	69
	Wylot	32	46	58	63	66	66	56	53	71
	Emitowany	14	40	52	52	57	51	42	35	60
6	Wlot	40	52	63	62	64	63	57	51	69
	Wylot	42	53	62	64	69	69	57	49	73
	Emitowany	24	47	57	51	57	52	41	28	61
7	Wlot	39	49	62	61	63	64	64	62	71
	Wylot	34	46	62	65	69	69	66	58	74
	Emitowany	24	44	56	50	56	53	48	39	61
8	Wlot	24	40	53	58	59	57	52	53	64
	Wylot	27	41	53	58	61	61	51	48	66
	Emitowany	9	34	47	47	52	46	37	30	55
9	Wlot	34	47	58	56	58	58	51	46	64
	Wylot	36	47	56	58	64	63	51	44	68
	Emitowany	19	41	52	45	51	47	36	23	56

## WYMIARY [mm]

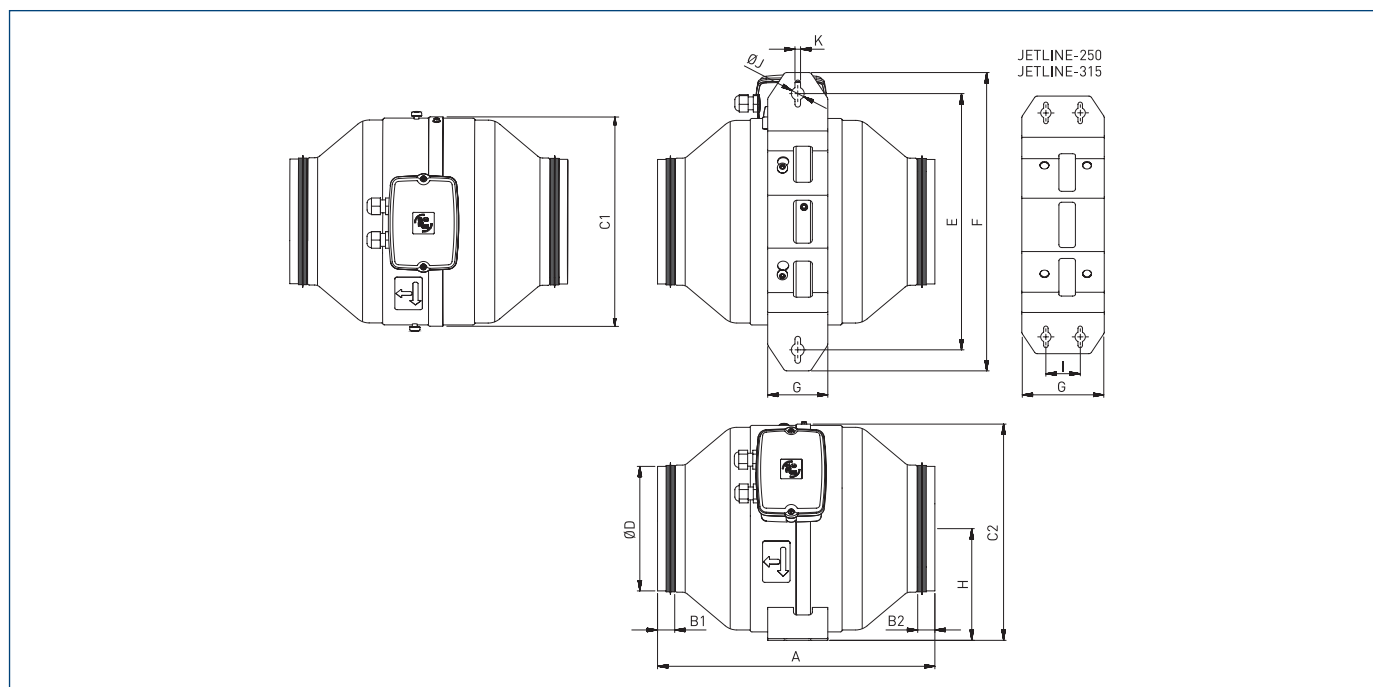

Typ	A	B1	B2	C1	C2	ØD	E	F	G	H	I	ØJ	K
JETLINE-100	276	15	15	181	190	95	256	306	70	98	-	15	6,5
JETLINE-125	279	15	15	206	214	120	265	315	70	111	-	15	6,5
JETLINE-150	323	20	20	243,5	252	145	298,5	348	70	130	-	15	6,5
JETLINE-160	323	20	20	243,5	252	155	298,5	348	70	130	-	15	6,5
JETLINE-200	322	30	30	273	281	195	320	369	100	144,5	-	15	6,5
JETLINE-250	329	20	30	293	301	245	326	375	120	154,3	50	15	6,5
JETLINE-315	369	20	33	322	331	310	357,5	407	120	170	50	15	6,5

## AKCESORIA MONTAŻOWE

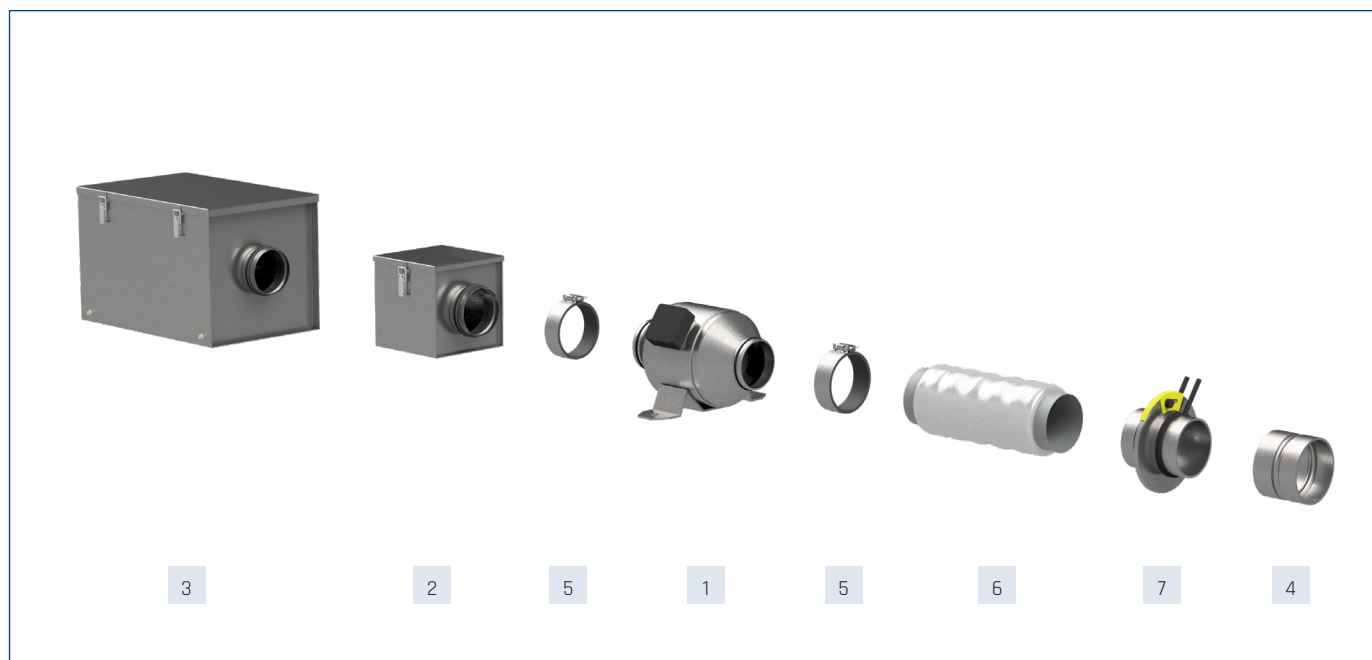

1 Wentylator	2 filtr kanałowy DF	3 filtr kanałowy DF-K				
			wkład filtracyjny do DF-K			
			EU3	EU5	EU7	EU9
JETLINE-100	DF 100	DF-K 100	EU3   100-250mm	EU5   100-250mm	EU7   100-250mm	EU9   100-250mm
JETLINE-125	DF 125	DF-K 125	EU3   100-250mm	EU5   100-250mm	EU7   100-250mm	EU9   100-250mm
JETLINE-150	DF 160*	DF-K 160*	EU3   100-250mm*	EU5   100-250mm*	EU7   100-250mm*	EU9   100-250mm*
JETLINE-160	DF 160	DF-K 160	EU3   100-250mm	EU5   100-250mm	EU7   100-250mm	EU9   100-250mm
JETLINE-200	DF 200	DF-K 200	EU3   100-250mm	EU5   100-250mm	EU7   100-250mm	EU9   100-250mm
JETLINE-250	DF 250	DF-K 250	EU3   100-250mm	EU5   100-250mm	EU7   100-250mm	EU9   100-250mm
JETLINE-315	DF 315	DF-K 315	EU3   315-450mm	EU5   315-450mm	EU7   315-450mm	-

1 Wentylator	4 klapa zwrotna CAR-PL	5 złącze przeciwdrganiowe ACOP PL	6 tłumik akustyczny AKU-COMP		7 przepustnica soczewk. IRIS	8 siatka ochronna DEF-VENT
			0,6m	1,2m		
JETLINE-100	CAR-PL 100	ACOP PL 100	AKU-COMP 100/0,6	AKU-COMP 100/1,2	IRIS 100	DEF-VENT-100
JETLINE-125	CAR-PL 125	ACOP PL 125	AKU-COMP 125/0,6	AKU-COMP 125/1,2	IRIS 125	DEF-VENT-125
JETLINE-150	CAR-PL 150	ACOP PL 150	AKU-COMP 160/0,6*	AKU-COMP 160/1,2*	IRIS 150	-
JETLINE-160	CAR-PL 160	ACOP PL 160	AKU-COMP 160/0,6	AKU-COMP 160/1,2	IRIS 160	DEF-VENT-160
JETLINE-200	CAR-PL 200	ACOP PL 200	AKU-COMP 200/0,6	AKU-COMP 200/1,2	IRIS 200	DEF-VENT-200
JETLINE-250	CAR-PL 250	ACOP PL 250	AKU-COMP 250/0,6	AKU-COMP 250/1,2	IRIS 250	DEF-VENT-250
JETLINE-315	CAR-PL 315	ACOP PL 315	AKU-COMP 315/0,6	AKU-COMP 315/1,2	IRIS 315	DEF-VENT-315

\* akcesoria montażowe dedykowane do średnicy 160mm

## Numery artykułów

ACOP PL 100	40521810	AKU-COMP 160/0.6	40521530	CAR-PL 160	40521030-01	DF-K 125	40521715	EU9   100-250mm	40520820	DEF-VENT-250	40522014
ACOP PL 125	40521815	AKU-COMP 160/1.2	40521630	CAR-PL 200	40521040-01	DF-K 160	40521720	IRIS 100	19527100	DEF-VENT-315	40522015
ACOP PL 150	40521818	AKU-COMP 200/0.6	40521540	CAR-PL 250	40521050-01	DF-K 200	40521725	IRIS 125	19527125		
ACOP PL 160	40521820	AKU-COMP 200/1.2	40521640	CAR-PL 315	40521060-01	DF-K 250	40521730	IRIS 160	19527160		
ACOP PL 200	40521825	AKU-COMP 250/0.6	40521550	DF 100	40520610	DF-K 315	40521735	IRIS 200	19527200		
ACOP PL 250	40521830	AKU-COMP 250/1.2	40521650	DF 125	40520620	EU3   100-250mm	40520800	IRIS 250	19527250		
ACOP PL 315	40521835	AKU-COMP 315/0.6	40521560	DF 160	40520630	EU3   315-450mm	40520830	IRIS 315	19527315		
AKU-COMP 100/0.6	40521510	AKU-COMP 315/1.2	40521660	DF 200	40520640	EU5   100-250mm	40520805	DEF-VENT-100	40522010		
AKU-COMP 100/1.2	40521510	CAR-PL 100	40521010-01	DF 250	40520650	EU5   315-450mm	40520835	DEF-VENT-125	40522011		
AKU-COMP 125/0.6	40521520	CAR-PL 125	40521020-01	DF 315	40520660	EU7   100-250mm	40520810	DEF-VENT-160	40522012		
AKU-COMP 125/1.2	40521520	CAR-PL 150	40521029-01	DF-K 100	40521710	EU7   315-450mm	40520840	DEF-VENT-200	40522013		

filtr DF	zest. filtr. DFK...+EU	klapa zwrotna CAR-PL	złącze p-drg. ACOP-PL	tłumik AKU-COMP	przepustnica IRIS	siatka ochr. DEF-VENT

## AKCESORIA ELEKTRYCZNE

Wentylator	automat. przełącznik biegów	termostat ścienny	termostat kanałowy	czujnik zanieczyszczeń	higrostat	regulator tyrystorowy		
	PBW					REB N	REB NE	VREB
JETLINE-100	PBW 2	TS	TK-1	SQA	HIG-2	REB-1 N	REB-1 NE	VREB 1,5H
JETLINE-125	PBW 2	TS	TK-1	SQA	HIG-2	REB-1 N	REB-1 NE	VREB 1,5H
JETLINE-150	PBW 3	TS	TK-1	SQA	HIG-2	REB-1 N	REB-1 NE	VREB 1,5H
JETLINE-160	PBW 3	TS	TK-1	SQA	HIG-2	REB-1 N	REB-1 NE	VREB 1,5H
JETLINE-200	PBW 3	TS	TK-1	SQA	HIG-2	REB-1 N	REB-1 NE	VREB 1,5H
JETLINE-250	PBW 3	TS	TK-1	SQA	HIG-2	REB-1 N	REB-1 NE	VREB 1,5H
JETLINE-315	PBW 3	TS	TK-1	SQA	HIG-2	REB-2,5 N	REB-2,5 NE	VREB 1,5H

Wentylator	2-nastawowy 6-biegowy regulator tyrystorowy	regulator transformatorowy		regulator transformatorowy 2-nastawowy	rozłącznik serwisowy
		RMB	RVS		
JETLINE-100	RND-1	RMB-1,5	RVS-1,5	SC2-1-15L25	R-S 1-F + SP, 16A
JETLINE-125	RND-1	RMB-1,5	RVS-1,5	SC2-1-15L25	R-S 1-F + SP, 16A
JETLINE-150	RND-1	RMB-1,5	RVS-1,5	SC2-1-15L25	R-S 1-F + SP, 16A
JETLINE-160	RND-1	RMB-1,5	RVS-1,5	SC2-1-15L25	R-S 1-F + SP, 16A
JETLINE-200	RND-1	RMB-1,5	RVS-1,5	SC2-1-15L25	R-S 1-F + SP, 16A
JETLINE-250	RND-1	RMB-1,5	RVS-1,5	SC2-1-15L25	R-S 1-F + SP, 16A
JETLINE-315	RND-1	RMB-1,5	RVS-1,5	SC2-1-15L25	R-S 1-F + SP, 16A

## Numery artykułów

PBW 2	40015500	PBW 3	40015505	TS	40025345	TK-1	40025330	SQA	40025140
HIG-2	40025150	REB-1 N	40025010	REB-2,5 N	40025030	REB-1 NE	40025020	REB-2,5 NE	40025040
VREB 1,5H	40025830	RND-1	40025630	RMB-1,5	40025060	RVS-1,5	40025232	SC2-1-15L25	40025250

przełącznik biegów PBW	termostat TS	termostat TK-1	czujnik SQA	higrostat HIG-2	regulator REB	regulator VREB	regulator RND-1	regulator RMB
regulator RVS	transformator 2-nastawowy	rozłącznik serwisowy						



## CHARAKTERYSTYKA ERP

		SWM*
	Nazwa produktu	JETLINE-100
a	Nazwa dostawcy	VENTURE INDUSTRIES / SOLER&PALAU
b	Numer artykułu	40021950
c	JZE umiarkowany (SEC Avarage) [kWh/m2rok]	-13,87
c	JZE chłodny (SEC cold)	-30
c	JZE ciepły (SEC warm)	-4
c	JZE (SEC) klasa	
d	Kategoria urządzenia	SWM (RVU)
d	Typ urządzenia	JSW (UVU)
e	Napęd	bezstopniowy
f	Typ odzysku ciepła	brak
g	Sprawność temperaturowa [%]	nie dotyczy
h	Maksymalny przepływ powietrza [m3/h]	184
i	Maksymalny pobór mocy [W]	19,11
j	Moc akustyczna [dB(A)]	28
k	Wartość odniesienia natężenia przepływu [m3/s]	0,0362
l	Wartość odniesienia różnicy ciśnienia [Pa]	45,65
m	JPM/SPI [W/m3/h]	0,1049
n	CRS/CTRL	1
o	Stopień zewnętrznych przecieków powietrza [%]	0,5
p	Stopień mieszania	nie dotyczy
q	Ostrzeżenia o konieczności wymiany filtra	nie dotyczy
r	Instrukcja instalowania kratki wentylacyjnych	nie dotyczy
s	Strona internetowa	venture.pl / solerpalau.com
t	Podatność przepływu na zmiany ciśnienia	nie dotyczy
u	Szczelność	nie dotyczy
v	Roczne zużycie energii elektrycznej-umiarkowany [kWh/m2rok]	1,31
v	Roczne zużycie energii elektrycznej-chłodny [kWh/m2rok]	1,31
v	Roczne zużycie energii elektrycznej-ciepły [kWh/m2rok]	1,31
w	ROO klimat chłodny	33,55
w	ROO klimat umiarkowany	17,15
w	ROO klimat ciepły	7,76

\* SWM-"system wentylacyjny przeznaczony do budynków mieszkalnych"-zgodnie z Rozporządzeniem Komisji (UE) nr 1254/2014

## CHARAKTERYSTYKA ERP

SWNM*				
	Nazwa produktu	JETLINE-125	JETLINE-150	JETLINE-160
a	Nazwa dostawcy	VENTURE INDUSTRIES / SOLER&PALAU	VENTURE INDUSTRIES / SOLER&PALAU	VENTURE INDUSTRIES / SOLER&PALAU
b	Numer artykułu	40021951	40021952	40021953
c	Kategoria urządzenia	SWNM (NRVU)	SWNM (NRVU)	SWNM (NRVU)
c	Typ urządzenia	JSW (UVU)	JSW (UVU)	JSW (UVU)
d	Napęd	bezstopniowy	bezstopniowy	bezstopniowy
e	Typ odzysku ciepła	brak	brak	brak
f	Sprawność temperaturowa [%]	nie dotyczy	nie dotyczy	nie dotyczy
g	Znamionowe natężenie przepływu w SWNM [m3/s]	0,07	0,12	0,13
h	Efektywny pobór mocy [kW]	0,04	0,08	0,08
i	JMWint [W/(m3/s)]	nie dotyczy	nie dotyczy	nie dotyczy
j	Prędkość czołowa [m/s]	2,25	2,96	3,18
k	$\Delta p_s$ , ext [Pa]	145,38	214,61	209,9
l	$\Delta p_s$ , int [Pa]	nie dotyczy	nie dotyczy	nie dotyczy
m	$\Delta p_s$ , add [Pa]	nie dotyczy	nie dotyczy	nie dotyczy
n	Sprawność statyczna wentylatora [%]	24,1	31,5	32,5
o	Stopień zewnętrznych przecieków powietrza [%]	0,1	0,4	0,3
p	Stopień wewnętrznych przecieków powietrza [%]	nie dotyczy	nie dotyczy	nie dotyczy
q	Efektywność energetyczna filtra	nie dotyczy	nie dotyczy	nie dotyczy
r	Ostrzeżenia o konieczności wymiany filtra	nie dotyczy	nie dotyczy	nie dotyczy
s	LWA [dB(A)]	41	45	44
s	Strona internetowa	venture.pl solerpalau.com	venture.pl solerpalau.com	venture.pl solerpalau.com

SWNM*				
	Nazwa produktu	JETLINE-200	JETLINE-250	JETLINE-315
a	Nazwa dostawcy	VENTURE INDUSTRIES / SOLER&PALAU	VENTURE INDUSTRIES / SOLER&PALAU	VENTURE INDUSTRIES / SOLER&PALAU
b	Numer artykułu	40021954	40021955	40021956
c	Kategoria urządzenia	SWNM (NRVU)	SWNM (NRVU)	SWNM (NRVU)
c	Typ urządzenia	JSW (UVU)	JSW (UVU)	JSW (UVU)
d	Napęd	bezstopniowy	bezstopniowy	bezstopniowy
e	Typ odzysku ciepła	brak	brak	brak
f	Sprawność temperaturowa [%]	nie dotyczy	nie dotyczy	nie dotyczy
g	Znamionowe natężenie przepływu w SWNM [m3/s]	0,19	0,23	0,28
h	Efektywny pobór mocy [kW]	0,12	0,16	0,21
i	JMWint [W/(m3/s)]	nie dotyczy	nie dotyczy	nie dotyczy
j	Prędkość czołowa [m/s]	3,8	3,83	4,07
k	$\Delta p_s$ , ext [Pa]	236,67	285,15	284,39
l	$\Delta p_s$ , int [Pa]	nie dotyczy	nie dotyczy	nie dotyczy
m	$\Delta p_s$ , add [Pa]	nie dotyczy	nie dotyczy	nie dotyczy
n	Sprawność statyczna wentylatora [%]	36,8	40,8	38,4
o	Stopień zewnętrznych przecieków powietrza [%]	0,7	0,5	0,8
p	Stopień wewnętrznych przecieków powietrza [%]	nie dotyczy	nie dotyczy	nie dotyczy
q	Efektywność energetyczna filtra	nie dotyczy	nie dotyczy	nie dotyczy
r	Ostrzeżenia o konieczności wymiany filtra	nie dotyczy	nie dotyczy	nie dotyczy
s	LWA [dB(A)]	57	59	64
s	Strona internetowa	venture.pl solerpalau.com	venture.pl solerpalau.com	venture.pl solerpalau.com

\* SWNM - "system wentylacyjny przeznaczony do budynków niemieszkalnych" - zgodnie z Rozporządzeniem Komisji (UE) nr 1253/2014.